



Tapered Pro Conical

prosthetic catalog



Tapered Pro Conical

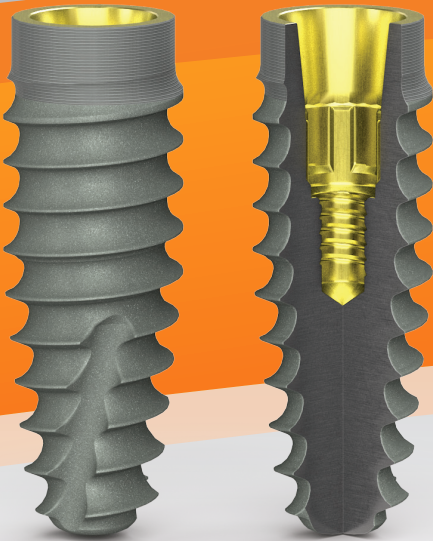

Based on the proven deep conical design from CONELOG®, and the Tapered Pro body, BioHorizons Tapered Pro Conical's design features provide a predictable solution for immediate treatment. It is designed for surgical efficiency with a best-in-class conical connection.¹

The implant's tapered body and aggressive thread design provide primary stability and its end-cutting, self-tapping helical cutting flutes are designed for controlled implant placement even in the most challenging sites.

With over 30 years of research, Tapered Pro Conical's unique Laser-Lok® microchannels create connective tissue attachment and retain crestal bone, allowing better control of esthetic outcomes.



Tapered Pro Conical's connection features a long conus designed to reduce micromovements and a 7.5° angulation that is proven to provide superior positional stability in comparison to other conical systems.¹

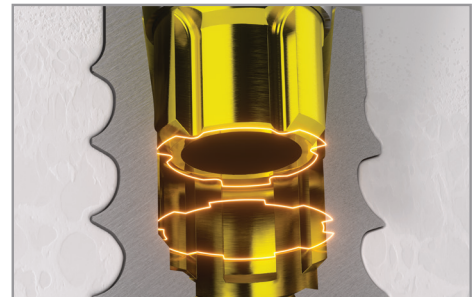

The 6-cam connection is designed for flexible abutment orientation options and simplified abutment insertion with anti-rotation capability.

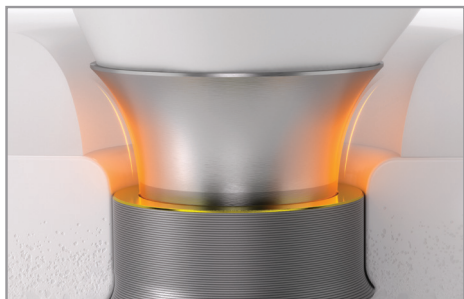

The flat implant shoulder is designed to reduce vertical discrepancy by allowing restorative components to sit on the implant shoulder preserving the conical connection for final abutments.

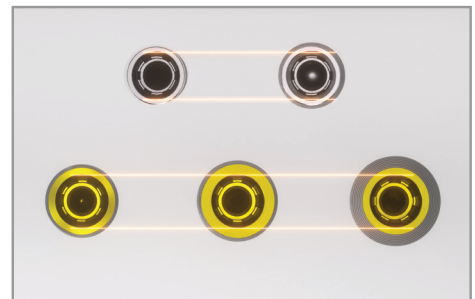

Using only two prosthetic platforms to improve restorative workflow efficiency and simplify inventory management.



Table of contents

Cover Screws & Healing Caps	4
Impression Components & Analogs	5
Abutments	6
Esthetic Abutments	7
CAD/CAM Abutments	8-9
OD Secure Abutments	10
Multi-unit Abutments & Components	11-14
Ancillary Instruments	15
Restorative Instruments	16-17
Ordering, Warranty Information & References	18

Prosthetic connection reference table



The Tapered Pro Conical system uses only two prosthetic platforms to improve restorative workflow efficiency and simplify inventory management. Please see the chart to determine the correct prosthetic platform for each implant size.

body diameter	prosthetic platform
3.3mm	 narrow
3.8mm	
4.2mm	 regular
4.6mm	
5.2mm	

Cover Screws & Healing Caps

Healing Stage

Conical Cover Screw



Part Number	Platform
CNCC	narrow
CRCC	regular

Healing Caps

Description: Temporary structure placed over the dental implant to support the healing process of the surrounding tissues. Per clinician's judgment, the healing cap will remain in place during the osseointegration phase of dental implant placement.

Regular Healing Caps

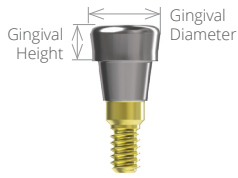

Part Number	Prosthetic connection	Gingival Height	Gingival Diameter
CNHA2	narrow	2.0mm	3.0mm
CNHA4		4.0mm	3.0mm
CNHA6		6.0mm	3.0mm
CRHA2	regular	2.0mm	3.8mm
CRHA4		4.0mm	3.8mm
CRHA6		6.0mm	3.8mm

Wide Healing Caps

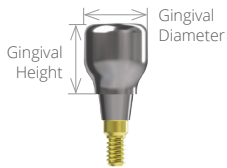

CNHA4W	narrow	4.0mm	4.8mm
CRHA4W	regular	4.0mm	5.3mm
CRHA6W		6.0mm	5.3mm

Extra Wide Healing Caps

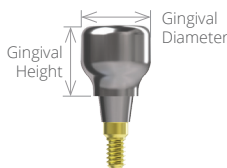

CRHA4EW	regular	4.0mm	5.8mm
CRHA6EW		6.0mm	5.8mm

Hand-tighten (10-15 Ncm) with the .050" (1.25mm) Hex Driver. Titanium alloy.

Impression Components & Analogs

Open & Closed Tray Components

Conical Impression Post, Open Tray



Part Number	Platform	Body Type
CNICO	narrow	Cylindrical
CRICO	regular	Cylindrical
CNICWO	narrow	Wide
CRICWO	regular	Wide

Use to make an open-tray, implant-level impression. Preassembled with an impression coping screw. Titanium alloy. Hand-tighten (10-15Ncm).

Conical Impression Post, Closed Tray



Part Number	Platform	Body Type
CNICC	narrow	Cylindrical
CRICC	regular	Cylindrical
CNICWC	narrow	Wide
CRICWC	regular	Wide

Use to make a closed-tray, implant-level impression. Preassembled with an impression coping screw. Titanium alloy. Hand-tighten (10-15 Ncm).

Conical Impression Cap for Impression Post, Closed Tray



Part Number	Platform
CNIC	narrow
CRIC	regular

5 units. POM.

Conical Implant Lab Analog



Part Number	Platform	Quantity
CNILA	narrow	Single Unit
CRILA	regular	Single Unit
CNILA25	narrow	25 Pack
CRILA25	regular	25 Pack

For printed & cast models. Titanium alloy.

Bite Registration Caps



Part Number	Platform
CNBRC	narrow
CRBRC	regular

Used with the closed-tray impression copings. 5 units. POM.

Abutment Screw

Crown & Bridge Restorations

Abutment Screw



Part Number	Platform	Quantity
CAS	narrow	Single Unit
	regular	
CAS25	narrow	25 pack
	regular	

For definitive screw retention of abutments into the implant. M 1.6 thread. Titanium alloy. Tighten to 20 Ncm.

Abutment Screws come packaged with:

- Temporary Abutments
- Gold Abutments
- Esthetic Abutments
- Ti Blank Abutments

Temporary Abutments

Temporary Crown & Bridge Restorations

Description: Use to construct a provisional restoration. This provisional restoration can be cemented on or integrated with a temporary abutment for a screw-retained prosthesis.

Conical Temporary Abutment, Engaging

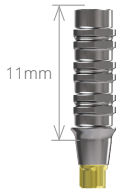

Part Number	Platform
CNTEA	narrow
CRTEA	regular

Preparable. Includes abutment screw. Titanium alloy. Tighten to 20 Ncm.

Conical Temporary Abutment, Non-engaging

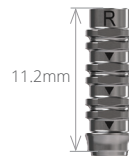

Part Number	Platform
CNTNA	narrow
CRTNA	regular

Preparable. Includes abutment screw. Titanium alloy. Tighten to 20 Ncm.

Gold Abutments

Crown and Bridge Restorations

Description: For single- or multiple-unit screw-retained or custom abutment cement-retained restorations. **Not for sale in the USA.**

Conical Gold-plastic Abutment

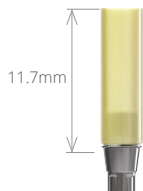

Part Number	Platform
CNGA	narrow
CRGA	regular

Includes abutment screw. Cast-on gold alloy/POM. Tighten to 20 Ncm.

Esthetic Abutments

Cemented Crown and Bridge Restorations

Description: For anterior and cement-retained restoration cases, BioHorizons esthetic abutments are designed to follow the scalloped gingiva and minimize the amount of modification.

Conical Straight Esthetic Abutment



Part Number	Body Type	Platform	Gingival Height	Gingival Width
CNSA2	Cylindrical	narrow	2.0mm	3.3mm
CRSA1	Cylindrical	regular	1.5mm	5.4mm
CRSA3	Cylindrical		3.0mm	5.4mm
CRSA1W	Wide	regular	1.5mm	5.9mm
CRSA3W	Wide		3.0mm	5.9mm

Preparable. Includes abutment screw. Titanium alloy. Tighten to 20 Ncm.

Conical 15° Esthetic Abutment



Part Number	Body Type	Platform	Gingival Height	Gingival Width
CR15A1	Cylindrical	regular	1.5mm	5.4mm
CR15A3	Cylindrical		3.0mm	5.4mm
CR15A1W	Wide	regular	1.5mm	5.9mm
CR15A3W	Wide		3.0mm	5.9mm

Preparable. Includes abutment screw. Titanium alloy. Tighten to 20 Ncm.

Conical 20° Esthetic Abutment



Part Number	Body Type	Platform	Gingival Height	Gingival Width
CR20A1	Cylindrical	regular	1.5mm	5.4mm
CR20A3	Cylindrical		3.0mm	5.4mm
CR20A1W	Wide	regular	1.5mm	5.9mm
CR20A3W	Wide		3.0mm	5.9mm

Preparable. Includes abutment screw. Titanium alloy. Tighten to 20 Ncm.

CAD/CAM Abutments

Crown, Bridge and Hybrid Restorations

The geometries of the Titanium bases CAD/CAM are available within a CAD library for leading dental CAD systems. The libraries are available for free download at: www.vulcandental.com/home/downloads

Description: For BioHorizons conical titanium bases, digitally designed abutments for use with Conical Ti Bases must be designed using appropriate design software (i.e., 3Shape, exocad) with appropriate library files installed. All digitally designed files are to be sent to a BioHorizons validated milling center for manufacture (i.e., Vulcan Dental for the USA).

Conical Ti Base, Engaging, Short Post



Part Number	Platform	Gingival Height
CNTE0S	narrow	0.8mm
CRTE0S	regular	
CNTE2S	narrow	2.0mm
CRTE2S	regular	

Bonding base for individual CAD/CAM fabricated dental prosthesis. Includes dark purple anodized Ti base abutment screw. Titanium alloy. Tighten to 20 Ncm.

Conical Ti Base, Engaging, Tall Post



Part Number	Platform	Gingival Height
CRTE0T	regular	0.8mm
CRTE2T	regular	2.0mm

Bonding base for individual CAD/CAM fabricated dental prosthesis. Includes dark purple anodized Ti base abutment screw. Titanium alloy. Tighten to 20 Ncm.

Conical Ti Base, Non-Engaging



Part Number	Platform	Gingival Height
CNTN0	narrow	0.8mm
CRTN0	regular	
CNTN2	narrow	2.0mm
CRTN2	regular	

Bonding base for individual CAD/CAM fabricated dental prosthesis. Includes dark purple anodized Ti base abutment screw. Titanium alloy. Tighten to 20 Ncm.

Description: CEREC compatible Conical Ti Bases may be used with Sirona CAD/CAM System in Coris ZI meso L and meso S to fabricate an abutment with an angle up to 20° by selecting their corresponding CONELOG® Titanium Base CAD/CAM in the CEREC software. All design parameters are according to the Sirona CAD/CAM System parameters. **Not for sale in the USA.**

Conical Ti Base, Engaging, CEREC Compatible



Part Number	Platform	Gingival Height	CONELOG® Titanium Base CAD/CAM in the CEREC software
CNTE0	narrow	0.8mm	Ti Base: Camlog - CONELOG 3.3/0.8
CRTE0	regular		Ti Base: Camlog - CONELOG 3.8/0.8
CNTE2	narrow	2.0mm	Ti Base: Camlog - CONELOG 3.3/2.0
CRTE2	regular		Ti Base: Camlog - CONELOG 3.8/2.0

Bonding base for individual CAD/CAM fabricated dental prosthesis. Includes dark purple anodized Ti base abutment screw. Titanium alloy. Tighten to 20 Ncm.

CAD/CAM Abutments

Crown, Bridge and Hybrid Restorations

Conical Ti Base Abutment Screw for CAD/CAM



Part Number	Platform	Quantity
CTAS	narrow	Single Unit
	regular	
CTAS25	narrow	25 pack
	regular	

Dark purple anodized. M 1.6 thread.
Titanium alloy. Tighten to 20 Ncm.

Conical Lab Screw for CAD/CAM



Part Number	Platform	Quantity
CLS	narrow	Single Unit
	regular	
CLS25	narrow	25 pack
	regular	

Brown partial anodized. M 1.6 thread.
Titanium alloy. Hand-tighten (10-15 Ncm).

Scanbody



Part Number	Platform
CNTSB	narrow
CRTSB	regular

For optical, 3-dimensional localization of Tapered Pro Conical Implants in the mouth or Conical lab analogs in the working model. Includes abutment screw, sterile. Titanium Alloy. Hand-tighten (10-15 Ncm).

ScanPost for CEREC® Scanbody



Part Number	Platform
CNCSP	narrow
CRCS	regular

For digital recording of the Conical Implant or lab analog position and for further processing in the CEREC® and inLab systems. Includes abutment screw. Titanium alloy. Hand-tighten (10-15 Ncm).

Description: Digitally designed abutments for use with Conical CAD/CAM Ti Blanks must be designed using appropriate design software (i.e., 3Shape, exocad) with appropriate library files installed. All digitally designed files are to be sent to a BioHorizons validated milling center for manufacture (i.e., Vulcan Dental for the USA).

Conical CAD/CAM Ti Blank, Type IAC



Part Number	Platform	Quantity
CNTBI	narrow	Single Unit
CRTBI	regular	

Includes abutment screw. Titanium alloy.
Tighten to 20 Ncm.

OD Secure Abutments

Full & Partial Dentures

Description: The OD Secure abutments are used to attach dentures and partial dentures to dental implants. With a full range of cuff heights for every platform (3.0mm–5.7mm), the OD Secure provides attachment solutions for all types of cases. The abutment is designed for easy delivery using an .050" hex driver and is color-coded to ensure that the abutment matches the implant platform. **Not for sale in the USA.**

Conical OD Secure Abutment

Part Number	Platform	Gingival Height
CNODS1	narrow	1.0mm
CNODS2		2.0mm
CNODS3		3.0mm
CNODS4		4.0mm
CRODS1	regular	1.0mm
CRODS2		2.0mm
CRODS3		3.0mm
CRODS4		4.0mm

The OD Secure comes packaged with the abutment, metal housing, four retentive inserts, a lab processing insert and a protection disk. Titanium alloy. TiN coated for esthetics. Tighten to 20 Ncm.



ODS-BS Block-out Spacer
4 pack



ODSIC Impression Coping
2 pack



ODSA OD Secure Analog
2 pack



ODSCT Cap Insert/Extractor Tool

OD Secure Abutment Components



ODS-CAK

Cap Assortment Kit
2 pack



ODS-HCPM

Housing Cap
2 pack

New pink Housing Cap comes assembled with Lab Processing Insert.



ODS-XH

Xtend Housing Cap
2 pack

Xtend Housing Cap assembled with Lab Processing Insert and is used to correct up to 50° of divergence.



ODS-XPM

Xtend Lab Processing Insert
4 pack



ODSRC-V

Retention Insert (violet)
Retention: 6lbs (Hard) 4 pack



ODSRC-C

Retention Insert (clear)
Retention: 4lbs (Medium) 4 pack



ODS-PM

Lab Processing Insert
4 pack



ODSRC-P

Retention Insert (pink)
Retention: 2.5lbs (Soft) 4 pack



ODSRC-Y

Retention Insert (yellow)
Retention: 1.5lbs (Extra Soft) 4 pack



ODSCM

Castable Male
2 pack

Multi-unit Abutments

Angled & Straight Abutments

Description: The Multi-unit Abutment is designed to rehabilitate both edentulous and partially edentulous arches.

Conical Multi-unit Straight Abutment



Part Number	Platform	Gingival Height
CNMUS2N	narrow	2.0mm
CNMUS3N		3.0mm
CNMUS4N		4.0mm
CRMUS2N	regular	2.0mm
CRMUS3N		3.0mm
CRMUS4N		4.0mm

Straight Multi-unit abutments may be used for multiple-unit screw-retained restorations at the abutment level, cast alloy bars for overdentures and fixed/detachable (hybrid) restorations. Pre-mounted with a multi-unit abutment carrier. Tighten to 20 Ncm.

Conical Multi-unit 17° Angled Abutment



Part Number	Platform	Gingival Height
CN17MU2	narrow	2.0mm
CN17MU3		3.0mm
CN17MU4		4.0mm
CR17MU2	regular	2.0mm
CR17MU3		3.0mm
CR17MU4		4.0mm

Angled Multi-unit abutments have a 60° offset cam arrangement, allowing a total of six rotating positions to obtain the optimal prosthetic axis. All angled multi-unit abutments are packaged with a multi-unit delivery handle and an angled multi-unit abutment screw. Tighten to 20 Ncm.

Conical Multi-unit 30° Angled Abutment



Part Number	Platform	Gingival Height
CN30MU2	narrow	2.0mm
CN30MU3		3.0mm
CN30MU4		4.0mm
CR30MU2	regular	2.0mm
CR30MU3		3.0mm
CR30MU4		4.0mm

Angled Multi-unit abutments have a 60° offset cam arrangement, allowing a total of six rotating positions to obtain the optimal prosthetic axis. All angled multi-unit abutments are packaged with a multi-unit delivery handle and an angled multi-unit abutment screw. Tighten to 20 Ncm.

Multi-unit Components

Try-Ins & Screws

Multi-unit Try-in Abutments may be used to measure tissue thickness and verify proper prosthetic seating prior to final abutment seating.

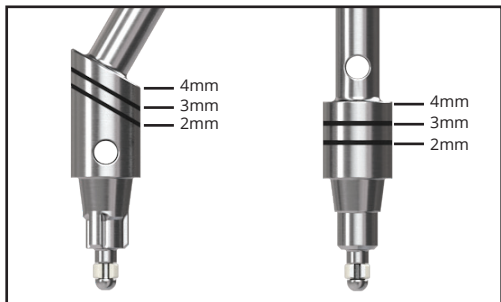

Conical Multi-unit Straight Abutment Try-in *

Part Number Platform

CNTRYS	narrow
CRTRYS	regular



Conical Multi-unit 17° Angled Abutment Try-in*

Part Number Platform

CNTRY17	narrow
CRTRY17	regular



Conical Multi-unit 30° Angled Abutment Try-in*

Part Number Platform

CNTRY30	narrow
CRTRY30	regular



CMUAS

Conical Angled Multi-unit abutment screw

CMUAS25

Conical Angled Multi-unit abutment screw (25 Pack)

For angled Multi-unit abutments only. Final torque: 20 Ncm with .050" (1.25mm).

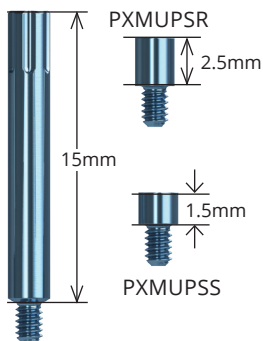

PXMUPSL

PXMUPSR

Prosthetic Screw, Multi-unit, Regular (pack of 5)

PXMUPSR25

Prosthetic Screw, Multi-unit, Regular (pack of 25)

PXMUPSL

Prosthetic Screw, Multi-unit, Long (pack of 5)

PXMUPSS

Prosthetic Screw, Multi-unit, Short (pack of 5)

For attaching copings to the Multi-unit abutments. Hand-tighten or torque to 15 Ncm with .050" (1.25mm) Hex Driver or Unigrip™ screw driver. Titanium alloy. Included with copings where indicated but can also be ordered separately.

* Instrument c-rings wear out over time. If an instrument is no longer held securely by its associated driver, order a replacement ring through Customer Care.

Multi-unit Components

Copings & Hex Adapters

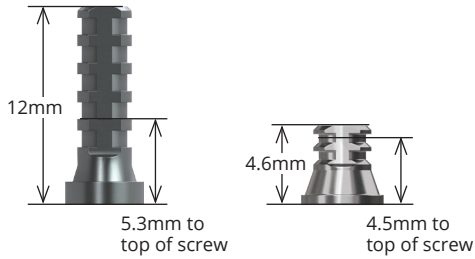

PXMUTC
PXMUTCS

Titanium Coping

Titanium Coping, Short

Use for fabricating acrylic temporary and final prostheses. May be trimmed for height. Packaged with prosthetic screw (PXMUPSR or PXMUPSS for Short Coping). Titanium alloy. Tighten to 15Ncm.

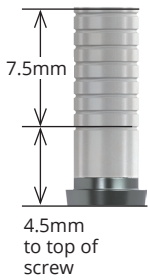

PXMUGC

Gold Custom Castable

Use for fabricating metal-reinforced acrylic prostheses or bar overdentures. May be trimmed for height. Packaged with prosthetic screw (PXMUPSR). Coping has a gold alloy base with acetal resin (Delrin® or Pomalux®) sleeve. Tighten to 15Ncm.

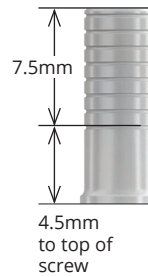

PXMUPC

Plastic Custom Castable

Use for fabricating metal-reinforced acrylic prostheses or bar overdentures. May be trimmed for height. Packaged with prosthetic screw (PXMUPSR). Acetal resin (Delrin® or Pomalux®). Tighten to 15Ncm.

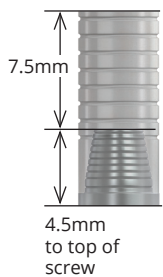

PXMUPFC

Passive Fit

Use for fabricating metal-reinforced acrylic prostheses or bar overdentures, cemented using the passive-fit technique. May be trimmed for height. Packaged with regular and long prosthetic screws (PXMUPSR, PXMUPSL). Coping has a titanium alloy base with acetal resin (Delrin® or Pomalux®) sleeve. Tighten to 15Ncm.



Handpiece

PXMUHAH

Handpiece Multi-unit Hex Adapter

Use to torque straight Multi-unit abutments. Driven by latch-type handpiece. Do not exceed 20 Ncm.



Manual

PXMUHAM

Manual Multi-unit Hex Adapter

Use to hand tighten straight Multi-unit abutments.



4mm Square

PXMUHAR*

4mm Square Multi-unit Hex Adapter

Use to torque straight Multi-unit abutments. Driven by 4mm square drive handwrench, ratchet, or torque wrench. Do not exceed 20 Ncm.

* Instrument c-rings wear out over time. If an instrument is no longer held securely by its associated driver, order a replacement ring through Customer Care.

Multi-unit Components

Impression Components

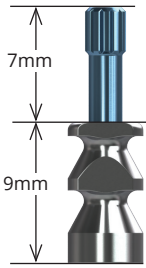

PXMUDPC

Direct Pick-up Coping, Multi-unit

Use to make a direct pick-up impression (open-tray) at the abutment level. Packaged with a prosthetic screw, long. Titanium alloy. Hand-tighten (10-15 Ncm).

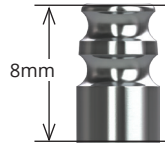

PXMUIC

Indirect Transfer Coping, Multi-unit

Use to make an indirect transfer (closed-tray) impression at the abutment level. Titanium alloy. Hand-tighten (10-15 Ncm).



PXMUCC

Cover Cap, Multi-unit

Hand-tighten with .050" (1.25mm) Hex Driver or Unigrip™ screw driver. Titanium alloy. Hand-tighten (10-15 Ncm).



PXMUCCC

Multi-unit contoured cover cap (pack of 2)

Flared emergence profile to suppress tissue during suturing. Hand-tighten with .050" (1.25mm) Hex Driver or Unigrip™ screw driver. PEEK body, titanium alloy screw. Hand-tighten (10-15 Ncm).



PXMUPA

Protection Analog, Multi-unit (pack of 5)

Use to protect abutment-coping interface when polishing the metal framework. Titanium alloy.



PXMUAR

Abutment Replica, Multi-unit

Use at lab to represent the Multi-unit/Implant assembly in the working cast. Not for use with implant-level impressions. Titanium alloy.

Ancillary Instruments

Miscellaneous Instruments



Surgical Driver

BIOTORQ

BioHorizons Adjustable Torque Wrench

Adjustable torque wrench designed to attach to all 4mm drivers from BioHorizons. Supplied with a dual direction mechanism that allows for insertion and removal functions. When the desired torque is reached (a choice of 10Ncm to 30Ncm) the torque wrench snaps to avoid over torquing.



Elos Adjustable Torque Wrench

C12374

Elos Adjustable Torque Wrench

C8521

Elos Replacement Bit, 4mm Square

C8381

Elos Replacement Bit, Handpiece

Lightweight titanium design is easy to use as a ratchet or adjustable torque wrench with visual indicators for 15, 30, 40, 50, 60, 70, 80 and 90 Ncm. Comes packaged with a 4mm square adaptor. Quickly disassembles for cleaning. No calibration required.



ITL Adjustable Torque Wrench

ATW

ITL Precise Adjustable Torque Wrench

Place both implants and abutments with 9 distinct torque settings (15, 20, 25, 30, 35, 40, 45, 50 and 60 Ncm). A simple twist of the handle locks in precision-engineered torque values and guarantees accuracy and repeatability. Fits any 4mm square component.



Prosthetic Kit

PROS3000

Enhanced Prosthetic Instrumentation Kit

Includes:

- .050" (1.25mm) Manual Hex Driver
- .050" (1.25mm) Manual Hex Driver, Long
- .050" (1.25mm) Handpiece Hex Driver
- .050" (1.25mm) Handpiece Hex Driver, Long
- .050" (1.25mm) 4mm Square Hex Driver
- .050" (1.25mm) 4mm Square Hex Driver, Long
- Hand Wrench
- 4mm Square Drive Extender
- 4mm Square Multi-unit Hex Adapter
- 12 Try-in Abutment Slots
- 8 Optional Instrument Slots
- Space for Torque Wrenches & AS123 Hand Unit

Multi-unit Try-in Abutments, 300-100 and ATW are sold separately.



Prosthetic Tray

PROS1500

Prosthetic Tray, Small

Restorative Instruments

Hex Drivers

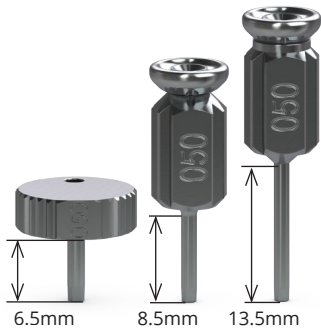

.050 (1.25mm) Manual Hex Drivers

135-251	Manual Hex Driver, Short
135-351	Manual Hex Driver
135-451	Manual Hex Driver, Long

For installation and removal of cover screws, healing caps and abutment screws.

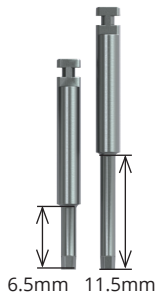

.050 (1.25mm) Handpiece Hex Drivers

134-350	Handpiece Hex Driver
134-450	Handpiece Hex Driver, Long

For installation and removal of cover screws, healing caps and abutment screws. The handpiece hex drivers are used with latch-type contra-angle handpieces. The Handpiece Hex Driver, Long (134-450) is 5mm longer than the standard version (134-350).

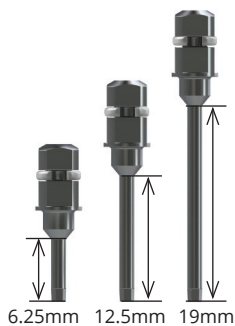

.050 (1.25mm) Ratchet/Wrench Hex Drivers*

300-350	4mm Square Hex Driver
300-351	4mm Square Hex Driver, Long
300-354	4mm Square Hex Driver, Extra Long

For installation and removal of cover screws, healing caps and abutment screws.

* Instrument c-rings wear out over time. If an instrument is no longer held securely by its associated driver, order a replacement ring through Customer Care.

Restorative Instruments

Miscellaneous Instruments



Disconnecter for Abutments*

CDTS	Disconnecter for abutments, short
CDTL	Disconnecter for abutments, long

For removal of Conical abutments from implants. Stainless steel.



Conical Ballpoint Drivers

CBDHS	Conical Ballpoint driver, handpiece, short
CBDHL	Conical Ballpoint driver, handpiece, long
CBDRS*	Conical Ballpoint driver, ratchet, short
CBDRL*	Conical Ballpoint driver, ratchet, long

Used with engaging titanium bases for angled screw channels.



CAIT	Conical Analog Insertion tool
-------------	-------------------------------



CBA	Conical Block-out Screw
------------	-------------------------

Used to prevent cement from blocking the screw channel access during the bonding of the restoration to the titanium base.

* Instrument c-rings wear out over time. If an instrument is no longer held securely by its associated driver, order a replacement ring through Customer Care.

Ordering & Warranty Information

Territory Manager: _____

cell phone: _____

email and/or fax: _____

BioHorizons Lifetime Warranty on Implants and Prosthetics for Clinicians: All BioHorizons implants and prosthetic components include a Lifetime Warranty. BioHorizons implant or prosthetic components will be replaced if removal of that product is due to failure (excluding normal wear to overdenture attachments).

Additional Warranties: BioHorizons warranties surgical drills, taps and other surgical and restorative instruments.

(1) Surgical Drills and Taps: Surgical drills and taps include a warranty period of ninety (90) days from the date of initial invoice. Surgical instruments should be replaced when they become worn, dull, corroded or in any way compromised. Surgical drills should be replaced after 12 to 20 osteotomies.²

(2) Instruments: The BioHorizons manufactured instrument warranty extends for a period of one (1) year from the date of initial invoice. Instruments include drivers, implant site dilators and BioHorizons tools used in the placement or restoration of BioHorizons implants.

Return Policy: Product returns require a Return Authorization Form, which may be acquired by contacting Customer Care. The completed Return Authorization Form must be included with the returned product. For more information, please see the reverse side of the invoice that was shipped with the product.

Disclaimer of Liability: BioHorizons products may only be used in conjunction with the associated original components and instruments according to the Instructions for Use (IFU). Use of any non-BioHorizons products in conjunction with BioHorizons products will void any warranty or any other obligation, expressed or implied.

Treatment planning and clinical application of BioHorizons products are the responsibility of each individual clinician. BioHorizons strongly recommends completion of postgraduate dental implant education and adherence to the IFU that accompany each product. BioHorizons is not responsible for incidental or consequential damages or liability relating to use of our products alone or in combination with other products other than replacement or repair under our warranties.

Distributed Products: For information on the manufacturer's warranty of distributed products, please refer to their product packaging. Distributed products are subject to price change without notice.

Validity: Upon its release, this literature supersedes all previously published versions.

Availability: Not all products shown or described in this literature are available in all countries. BioHorizons continually strives to improve its products and therefore reserves the right to improve, modify, change specifications or discontinue products at any time.

Any images depicted in this literature are not to scale, nor are all products depicted. Product descriptions have been modified for presentation purposes. For complete product descriptions and additional information, visit store.biohorizons.com.

References

1. Semper-Hogg, W et al. Analytical and experimental position stability of the abutment in different dental implant systems with a conical implant-abutment connection. *Clinical Oral Investigation* (2013) 17: 1017.
2. Heat production by 3 implant drill systems after repeated drilling and sterilization. Chacon GE, Bower DL, Larsen PE, McGlumphy EA, Beck FM. *J Oral Maxillofac Surg*. 2006 Feb;64(2):265-9. R30003b

Direct Offices

BioHorizons USA
888-246-8338 or 205-967-7880

BioHorizons Canada
866-468-8338

BioHorizons Spain
+34 91 713 10 84

BioHorizons UK
+44 (0)1344 752560

BioHorizons Chile
+56 (2) 23619519

BioHorizons Italy
800-063-040

BioHorizons Mexico
800-953-0498

Distributors

For contact information in our 90 countries, visit biohorizons.com



shop online at
store.biohorizons.com

BioHorizons®, Laser-Lok®, MinerOss®, AutoTac®, Mem-Lok®, TeethXpress®, IntraSpin®, L-PRF® and Xpression® are registered trademarks of BioHorizons Implant Systems Inc. Genate™ is a trademark of BioHorizons. Unigrip™ is a trademark of Nobel Biocare AB. Zimmer® Dental ScrewVent® and Tapered ScrewVent® are registered trademarks of Zimmer, Inc. AlloDerm SELECT™, AlloDerm SELECT GBR™ and NovoMatrix™ are trademarks of Allergan, an AbbVie company. Grafton® DBM is a registered trademark of Medtronic, Inc. Cytoplast® is a registered trademark of Osteogenics Biomedical, Inc. Puros Dermis is a registered trademark of Zimmer Biomet. Mucograft is a registered trademark of Ed. Geistlich Sogne Ag Fur Chemische Industrie. Symbios PerioDerm is a registered trademark of Dentsply Sirona. Hu-Friedy® is a registered trademark of Hu-Friedy Mfg. Co., LLC. Spiralock® is a registered trademark of Spiralock Corporation. Pomalux® is a registered trademark of Westlake Plastics Co. Locator® is a registered trademark of Zest Anchors, Inc. Delrin® is a registered trademark of E.I. du Pont de Nemours and Company. Bio-Gide® is a registered trademark of Edward Geistlich Sohne AG Fur Chemische Industrie. BioMend® is a registered trademark of Zimmer Biomet Dental. Not all products shown or described in this literature are available in all countries. We are proud to be registered to ISO 13485:2016, the international quality management system standard for medical devices, which supports and maintains our product licences with Health Canada and in other markets around the globe. Original language is English. ©BioHorizons. All Rights Reserved.



L02092



REV C JUL 2024