

Tapered Pro
Conical
catalog & surgical manual

BIOHORIZON[®]

30 years of making connections

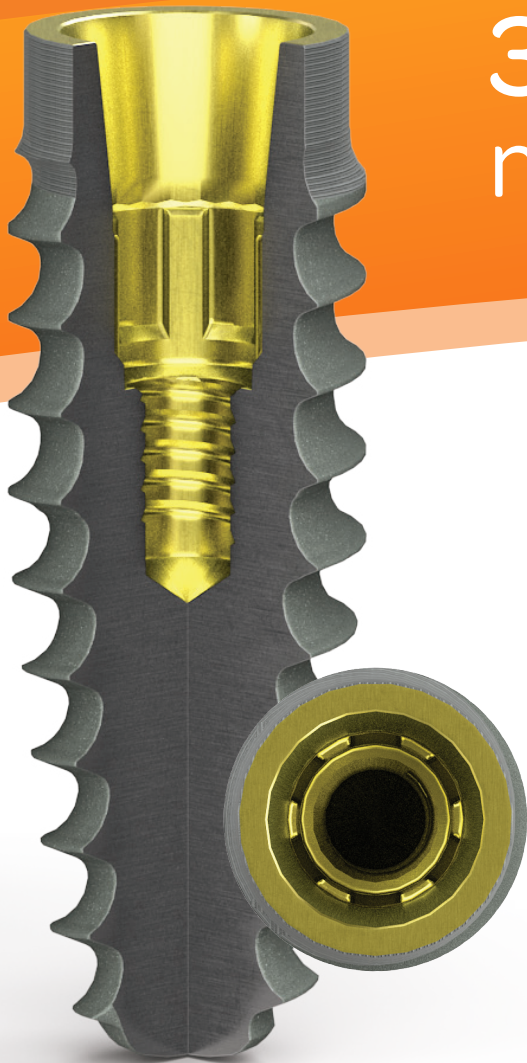

BioHorizons Tapered Pro Conical

Based on the proven deep conical design from CONELOG®, and the Tapered Pro body, BioHorizons Tapered Pro Conical's design features provide a predictable solution for immediate treatment. It is designed for surgical efficiency with a best-in-class conical connection.¹

CONELOG connection history

The CONELOG® Implant System was introduced in 2011 by Camlog to enlarge its offerings with conical implant-abutment connections. CONELOG® Implants have a 7.5° self-locking inner taper and three internal grooves.



- 2011 connection first introduced
- 2013 superior positional stability in comparison to other conical systems¹
- 2015 multi-center study demonstrates enhancement and preservation of crestal bone²
- 2020 long term follow-up demonstrates reliable peri-implant tissue stability over 7 years³

table of contents

Tapered Pro Conical Overview	3-4
Implant Portfolio & Surgical Kits	5-6
Healing & Temporary	7
Pro Surgical Drills	8
Short Surgical Drills	9
Ancillary Drills	10
Surgical Instruments	11
Miscellaneous Instruments	12-13
Restorative Instruments	14
Instructions for Use	15
Surgical Protocols	16
Implant Placement Level & Spacing	17
Surgical Kit & Drill Sequence	18-19
Osteotomy Modification	20-21
Implant Transfer	22
Tapered Short Conical Indications & Osteotomy Initialization	23
Tapered Short Conical Osteotomy Modification	24-25
Tapered Short Conical Transfer	26
Healing Protocols	27
Appendix	28
Icon Legend	29
Ordering & Warranty Information	30

Tapered Pro Conical

The implant's tapered body and aggressive thread design provide primary stability and its end-cutting, self-tapping helical cutting flutes are designed for controlled implant placement even in the most challenging sites. With over 30 years of research, Tapered Pro Conical's unique Laser-Lok® microchannels create a connective tissue attachment and retain crestal bone, allowing better control of esthetic outcomes.



1 7.5° conical connection
Tapered Pro Conical's connection features a long conus designed to reduce micromovements and a 7.5° angulation that is proven to provide superior positional stability in comparison to other conical systems.²

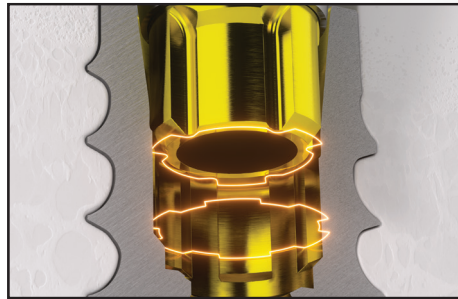

2 6-cam connection
The 6-cam connection is designed for flexible abutment orientation options and direct-drive for simpler implant insertion.

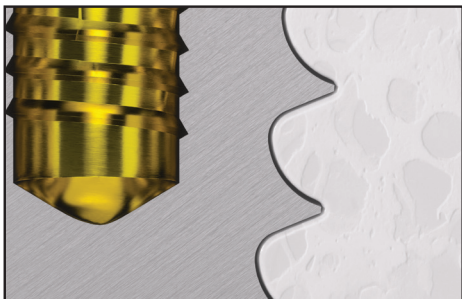

3 aggressive threadform
Deep, buttress threads are designed to provide primary stability.

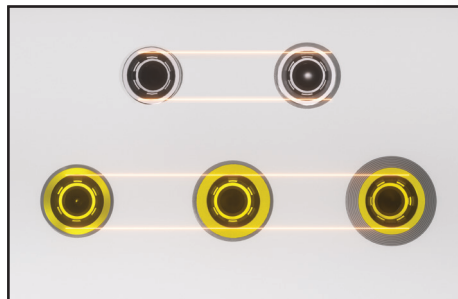

two prosthetic platforms
Using only two prosthetic platforms to improve restorative workflow efficiency and simplify inventory management.

streamlined clinical performance

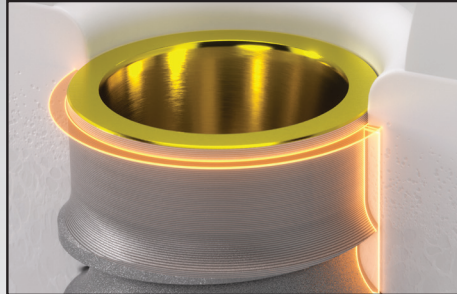

4 platform-switching
Featuring platform-switching, designed to preserve crestal bone and deliver esthetic results.

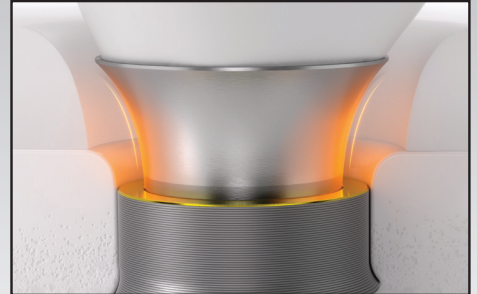

4 flat implant shoulder
The flat implant shoulder is designed to reduce vertical discrepancy by allowing restorative components to sit on the implant shoulder preserving the conical connection for final abutments.

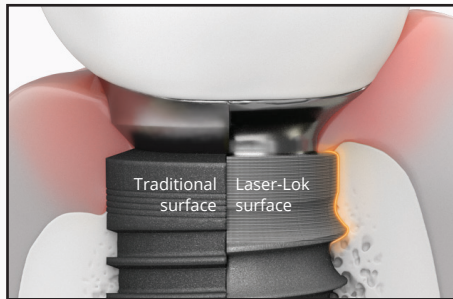

5 Laser-Lok zone & reduced collar
Equipped with Laser-Lok surface treatment shown to create a connective tissue attachment and retain crestal bone. The reduced collar diameter is designed to preserve vital bone.

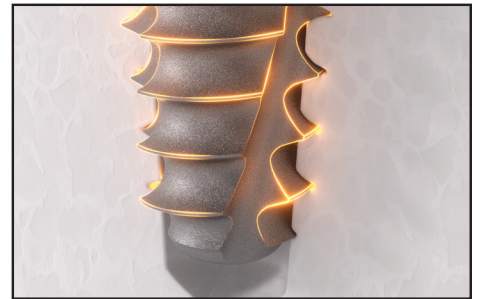

6 end cutting design
End cutting, self-tapping, helical cutting flutes designed for controlled placement.

surgical flexibility

BioHorizons Tapered Pro Conical implants and Tapered Short Conical implants can be placed with the Pro Freehand Kit.

For guided placement, BioHorizons Tapered Pro Conical implants can be placed with the keyless guided Pro Surgical Kit.



4

5

6

Tapered Conical

Implant Portfolio

Tapered Pro Conical

Body diameter	3.3mm	3.8mm	4.2mm	4.6mm	5.2mm
Prosthetic connection	Narrow	Narrow	Regular	Regular	Regular
Platform switch	0.3mm	0.3mm	0.4mm	0.6mm	0.9mm
Laser-Lok zone	1.8mm	1.8mm	1.8mm	1.8mm	1.8mm
Apical diameter	2.4mm	2.8mm	3.0mm	3.2mm	3.3mm
9.0mm length	CTA3309	CTA3809	CTA4209	CTA4609	CTA5209
10.5mm length	CTA3310	CTA3810	CTA4210	CTA4610	CTA5210
12.0mm length	CTA3312	CTA3812	CTA4212	CTA4612	CTA5212
15.0mm length	CTA3315	CTA3815	CTA4215	CTA4615	CTA5215
18.0mm length	CTA3318	CTA3818	CTA4218	CTA4618	—

Tapered Short Conical

Body diameter	4.2mm	4.6mm	5.2mm
Prosthetic connection	Regular	Regular	Regular
Platform switch	0.6mm	0.8mm	1.0mm
Laser-Lok zone	1.8mm	1.8mm	1.8mm
Apical diameter	3.3mm	3.7mm	4.2mm
7.5mm length	CTA4207	CTA4607	CTA5207

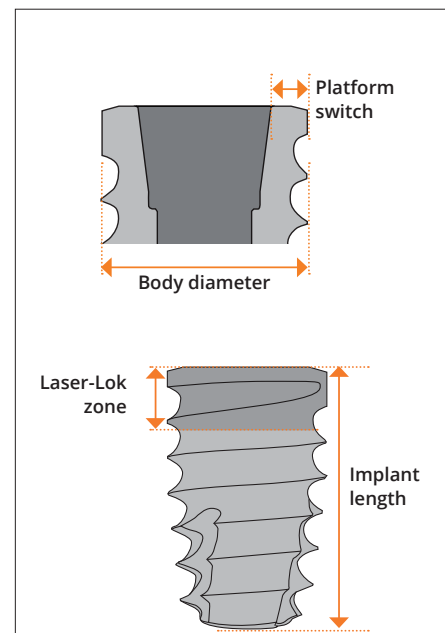

Surgical Kits

Pro Freehand & Guided Surgery Kits

Pro Freehand Surgical Kit

FSK5000

Pro Freehand Surgical Kit

Includes the instrumentation required to place:
Tapered Pro, Tapered Pro Conical and Tapered Short Conical.
Also supports: Tapered Short, Tapered PTG, Tapered Plus,
Tapered 3.0, Tapered Tissue Level and Tapered Internal implants.

FSK4500

Pro Freehand Empty Kit
(without instruments)

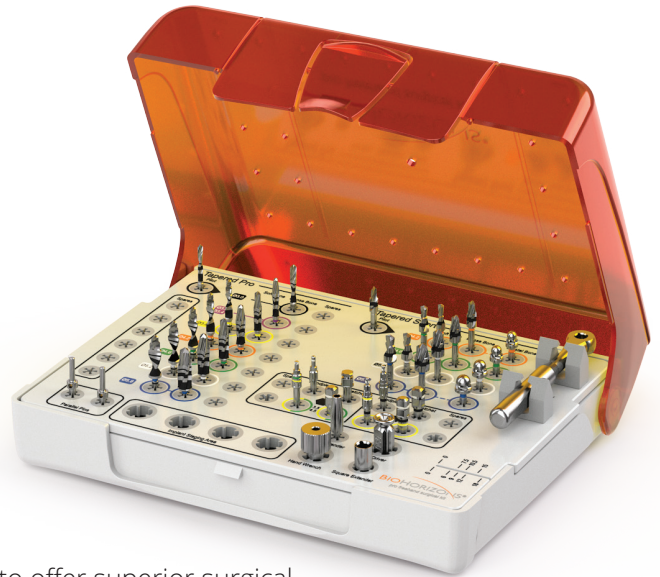

The Pro Freehand Surgical Kit from BioHorizons is designed to offer superior surgical efficiency. The surgical kit is equipped with a parabolic drill design which provides flexibility with the choice of two different implant placement protocols in a single kit, reduced and conventional. The Pro Freehand kit is compatible with conical and internal hex connections and places regular and short implant lines.

features:

- Compact layout for easy use in all operatory settings
- Flexible implant placement with the choice between reduced and conventional protocols
- Versatile lid with opening greater than 180° and removable
- Intuitive color-coded layout based on implant diameter for simplified surgical workflow
- Drills are marked and color-coded for seamless identification of selected protocol
- Simplified layout and color-coding for easier disassembly and reassembly during cleaning
- Empty spare slots allowing personalization of kit

Guided Surgery Kit

PRO5000

Pro Guided Kit *(with instruments)*

Includes the instrumentation required to place:
Tapered Pro, Tapered Pro Conical.
Also supports: Tapered PTG, Tapered Plus, Tapered 3.0,
Tapered Tissue Level and Tapered Internal implants.*

* 5.8mm Tapered Internal implants are not supported by the PRO5000 kit. Spare slots may be used to customize the kit.

Important Note about Guided Surgery Kit:

Surgical protocol & guide partners for the PRO5000 can be found at:

<https://www.biohorizons.com/Products/ProSurgicalSystem>

Reference L02087 for more information.

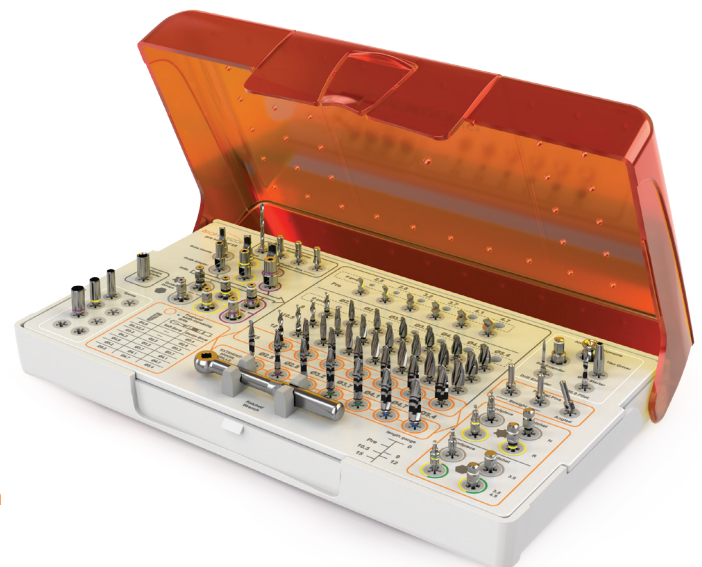

Healing & Temporary

Cover Screws, Healing Caps & Temporary Abutments



Conical Cover Screw

Part Number	Diameter
CNCC	narrow
CRCC	regular

Regular Healing Caps

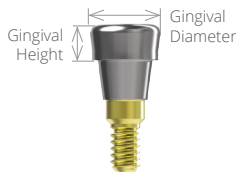

Part Number	Prosthetic connection	Gingival Height	Gingival Diameter
CNHA2	narrow	2.0mm	3.0mm
CNHA4		4.0mm	3.0mm
CNHA6		6.0mm	3.0mm
CRHA2	regular	2.0mm	3.8mm
CRHA4		4.0mm	3.8mm
CRHA6		6.0mm	3.8mm

Wide Healing Caps



CNHA4W	narrow	4.0mm	4.8mm
CRHA4W	regular	4.0mm	5.3mm
CRHA6W		6.0mm	5.3mm

Extra Wide Healing Caps



CRHA4EW	regular	4.0mm	5.8mm
CRHA6EW		6.0mm	5.8mm

Hand-tighten (10-15 Ncm) with the .050" (1.25mm) Hex Driver. Titanium alloy.

Conical Temporary Abutment, Engaging

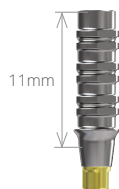

Part Number	Diameter
CNTEA	narrow
CRTEA	regular

Preparable. Includes abutment screw. Titanium alloy. Tighten to 20Ncm.

Conical Temporary Abutment, Non-engaging

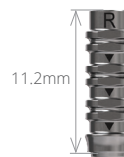

Part Number	Diameter
CNTNA	narrow
CRTNA	regular

Preparable. Includes abutment screw. Titanium alloy. Tighten to 20Ncm.

Individual Components

Pro Surgical Drills

Tapered Pilot Drill

TSD2020PD

Tapered Pilot Drill, 2.0mm



Tapered Soft Bone Drills

TSD2028SB
TSD2032SB
TSD2037SB
TSD2041SB
TSD2047SB

Tapered Soft Bone Drill, 2.8mm
Tapered Soft Bone Drill, 3.2mm
Tapered Soft Bone Drill, 3.7mm
Tapered Soft Bone Drill, 4.1mm
Tapered Soft Bone Drill, 4.7mm



The tapered soft bone drills feature a parabolic design which allows for highly efficient drilling. The simplified drill markings correspond to the implant lengths and are color-coded by implant diameter.

Tapered Dense Bone Drills

TSD2025DB
TSD2028DB
TSD2032DB
TSD2037DB
TSD2041DB
TSD2047DB
TSD2054DB

Tapered Dense Bone Drill, 2.5mm
Tapered Dense Bone Drill, 2.8mm
Tapered Dense Bone Drill, 3.2mm
Tapered Dense Bone Drill, 3.7mm
Tapered Dense Bone Drill, 4.1mm
Tapered Dense Bone Drill, 4.7mm
Tapered Dense Bone Drill, 5.4mm



Used to widen the osteotomy in a dense bone environment. The dense bone drills come with depth markings for reference and their matte finish allows for increased visibility in an operatory setting.

Individual Components

Short Surgical Drills

Tapered Short Pilot Drill

TDS32PD	Tapered Short Pilot Drill, 2.2/3.2mm
---------	--------------------------------------



Tapered Short Soft Bone Drills

TDS33SB	Tapered Short Soft Bone Drill, 2.4/3.3mm
TDS37SB	Tapered Short Soft Bone Drill, 2.8/3.7mm
TDS42SB	Tapered Short Soft Bone Drill, 3.2/4.2mm
TDS47SB	Tapered Short Soft Bone Drill, 3.6/4.7mm

The tapered short soft bone drills feature a parabolic design which allows for highly efficient drilling. The drills are color coded by implant diameter.



Tapered Short Dense Bone Drills

TDS37DB	Tapered Short Dense Bone Drill, 3.7mm
TDS42DB	Tapered Short Dense Bone Drill, 4.2mm
TDS48DB	Tapered Short Dense Bone Drill, 4.8mm
TDS54DB	Tapered Short Dense Bone Drill, 5.4mm

The Tapered Short Dense Bone drills feature highly efficient cutting flutes for crisp osteotomies in even the densest bone.



Tapered Short Crestal Bone Drills

TDS42CB	Tapered Short Crestal Bone Drill, 4.2mm
TDS46CB	Tapered Short Crestal Bone Drill, 4.6mm
TDS52CB	Tapered Short Crestal Bone Drill, 5.2mm
TDS58CB	Tapered Short Crestal Bone Drill, 5.8mm

Used to remove cortical bone at ridge crest to facilitate pressure-free seating of the implant collar; indicated when dense cortical bone is present at crest; rounded non-end cutting hub centers drill in osteotomy. The drill's rounded non-end cutting hub centers drill in the osteotomy.



Individual Components

Ancillary Drills



2.5mm Tapered Depth Drills with Stops

TSD202507HD	2.5mm Tapered Depth Drill, 7.5mm Stop
TSD202509HD	2.5mm Tapered Depth Drill, 9mm Stop
TSD202510HD	2.5mm Tapered Depth Drill, 10.5mm Stop
TSD202512HD	2.5mm Tapered Depth Drill, 12mm Stop
TSD202515HD	2.5mm Tapered Depth Drill, 15mm Stop

Stops are set to same length as each implant for crestal placement.



Extended Shank HD Drills

TSD4020HD	2.0mm Extended Shank HD Drill
TSD4025HD	2.5mm Extended Shank HD Drill
TSD4028HD	2.8mm Extended Shank HD Drill
TSD4032HD	3.2mm Extended Shank HD Drill
TSD4037HD	3.7mm Extended Shank HD Drill
TSD4041HD	4.1mm Extended Shank HD Drill
TSD4047HD	4.7mm Extended Shank HD Drill

Extended Shank Drills are 8mm longer than standard drills.



Burs

122-015	1.5mm Starter Drill
---------	---------------------

The 1.5mm starter drill facilitates precise initiation of osteotomies and features a 10.5mm depth marking.

122-110	2.0mm Lindemann Bone Cutter
---------	-----------------------------

Side-cutting drill used to correct eccentric osteotomy preparations.

122-106	#6 Round Bur
---------	--------------

Individual Components

Surgical Instruments



Narrow Implant-level Drivers*

CNIDR
CNIDRL
CNIDH

- Conical Narrow Implant-level Driver, Ratchet
- Conical Narrow Implant-level Driver, Long Ratchet
- Conical Narrow Implant-level Driver, Handpiece



Regular Implant-level Drivers*

CRIDR
CRIDH

- Conical Regular Implant-level Driver, Ratchet
- Conical Regular Implant-level Driver, Handpiece



300-205
4mm Square Drive Extender*



300-400
Hand Wrench



135-351
050" (1.25mm) Hex Driver



130-000
Ratchet



122-100
Drill Extender



144-100
Straight Parallel Pins
(2 per kit)



144-200
20° Angled Parallel Pins



144-230
30° Angled Parallel Pins

* Instrument c-rings wear out over time. If an instrument is no longer held securely by its associated driver, order a replacement ring through Customer Care.

Ancillary Instruments

Miscellaneous Instruments



Tissue Punches

122-200	3.0mm Tissue Punch <i>(for a 3.3mm incision)</i>
PYTP	3.5mm Tissue Punch <i>(for a 3.9mm incision)</i>
PGTP	4.5mm Tissue Punch <i>(for a 4.7mm incision)</i>

Use in flapless surgical procedures to remove a minimal amount of the soft tissue from the crest of the ridge prior to osteotomy preparation or during implant uncover.

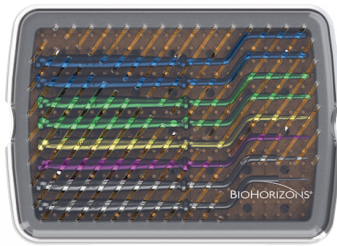

Tapered Offset Dilator Kit

TODKIT2	Tapered Offset Site Dilator Kit
----------------	--

The Tapered Implant site dilators match the geometry of the Tapered surgical drills and are used to create or enlarge osteotomies in soft maxillary bone. These instruments compress the bone laterally rather than removing valuable bone from the surgical site, creating a more dense bone-to-implant interface.



Bone Profiling Burs

CNBP	Conical Bone Profiler, Narrow
CRBP	Conical Bone Profiler, Regular

Use at implant uncover to remove excess crestal bone for proper abutment seating. Screw the guide into the implant and align the profiling bur for precise bone removal. Match profiler & guide color to prosthetic connection.

Ancillary Instruments

Miscellaneous Instruments



Surgical Driver

BIOTORQ

BioHorizons Adjustable Torque Wrench

Adjustable torque wrench designed to attach to all 4mm drivers from BioHorizons. Supplied with a dual direction mechanism that allows for insertion and removal functions. When the desired torque is reached (a choice of 10Ncm to 30Ncm) the torque wrench snaps to avoid over torquing.



Elos Adjustable Torque Wrench

C12374

Elos Adjustable Torque Wrench

C8521

Elos Replacement Bit, 4mm Square

C8381

Elos Replacement Bit, Handpiece

Lightweight titanium design is easy to use as a ratchet or adjustable torque wrench with visual indicators for 15, 30, 40, 50, 60, 70, 80 and 90 Ncm. Comes packaged with a 4mm square adaptor. Quickly disassembles for cleaning. No calibration required.



ITL Adjustable Torque Wrench

ATW

ITL Precise Adjustable Torque Wrench

Place both implants and abutments with 9 distinct torque settings (15, 20, 25, 30, 35, 40, 45, 50 and 60 Ncm). A simple twist of the handle locks in precision-engineered torque values and guarantees accuracy and repeatability. Fits any 4mm square component.

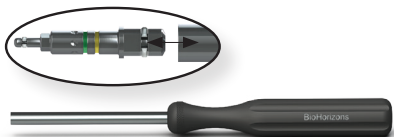

Surgical Driver

150-000

Surgical Driver

Use to drive implants into the osteotomy, particularly in the anterior region. Holds the 4mm Square implant-level drivers and the bone taps.

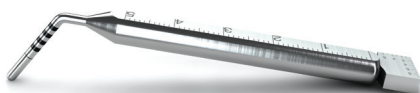

Implant Spacer / Depth Probe

144-300

Implant Spacer / Depth Probe

Use to provide intraoral measurements. Multi-functional tool for marking implant spacing on the ridge and probing osteotomy depth.

Restorative Instruments

Hex Drivers

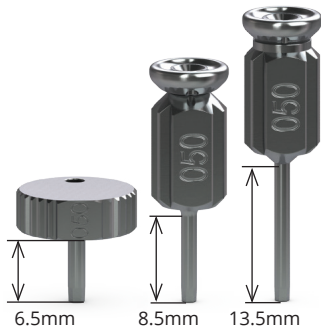

.050 (1.25mm) Manual Hex Drivers

135-251	Manual Hex Driver, Short
135-351	Manual Hex Driver
135-451	Manual Hex Driver, Long

For installation and removal of cover screws, healing caps and abutment screws.

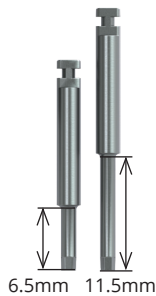

.050 (1.25mm) Handpiece Hex Drivers

134-350	Handpiece Hex Driver
134-450	Handpiece Hex Driver, Long

For installation and removal of cover screws, healing abutments and abutment screws. The handpiece hex drivers are used with latch-type contra-angle handpieces. The Handpiece Hex Driver, Long (134-450) is 5mm longer than the standard version (134-350).

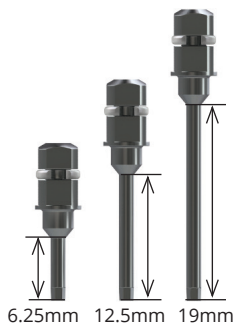

.050 (1.25mm) Ratchet/Wrench Hex Drivers*

300-350	4mm Square Hex Driver
300-351	4mm Square Hex Driver, Long
300-354	4mm Square Hex Driver, Extra Long

For installation and removal of cover screws, healing caps and abutment screws.

* Instrument c-rings wear out over time. If an instrument is no longer held securely by its associated driver, order a replacement ring through Customer Care.

Surgical Manual

Instructions for Use

Tapered Pro Conical Surgical Manual

This surgical manual serves as a reference for using the Tapered Pro Conical implants and surgical instruments. It is intended solely to provide instructions on the use of BioHorizons products. It is not intended to describe the methods or procedures for diagnosis, treatment planning, or placement of implants, nor does it replace clinical training or a clinician's best judgment regarding the needs of each patient. BioHorizons strongly recommends appropriate training as a prerequisite for the placement of implants and associated treatment.

The procedures illustrated and described within this manual reflect idealized patient presentations with adequate bone and soft tissue to accommodate implant placement. No attempt has been made to cover the wide range of actual patient conditions that may adversely affect surgical and prosthetic outcomes. **Clinician judgment as related to any specific case must always supersede any recommendations made in this or any BioHorizons literature.**



Before beginning any implant surgical procedure with BioHorizons implants:

- *Read and understand the Instructions for Use that accompany the products.*
- *Clean and sterilize the surgical tray and instruments per Instructions for Use.*
- *Become thoroughly familiar with all instruments and their uses.*
- *Study surgical kit layout and iconography.*
- *Design a surgical treatment plan to satisfy the prosthetic requirements of the case.*



Small diameter implants are intended for the anterior region of the mouth and are not intended for the posterior region of the mouth due to possible failure of the implant.

Indications For Use

BioHorizons Tapered Pro Conical dental implants are intended for use in the mandible or maxilla for use as an artificial root structure for single tooth replacement or for fixed bridgework and dental retention. These dental implants may be restored immediately (1) with a temporary prosthesis that is not in functional occlusion or (2) when splinted together for multiple tooth replacement or when stabilized with an overdenture supported by multiple implants.

Important Considerations

- Peri-operative oral rinses with a 0.12% Chlorhexidine Digluconate solution have been shown to significantly lower the incidence of post-implantation infectious complications.⁴ A pre-operative 30-second rinse is recommended, followed by twice daily rinses for two weeks following surgery.
- Drilling must be done under a constant stream of sterile irrigation. A pumping motion should be employed to prevent over-heating the bone. Surgical drills and taps should be replaced when they are worn, dull, corroded or in any way compromised. BioHorizons recommends replacing drills after 12 to 20 osteotomies.⁵ A Drill-usage Tracking Chart is available at biohorizons.com to record this important information.
- There is a risk of injury to the mandibular nerve associated with surgical drilling in posterior mandibular regions. To minimize the risk of nerve injury, it is imperative that the clinician understands the drill depth markings as they relate to the implant length to produce the desired vertical placement of the implant.

Surgical Manual

Surgical Protocols

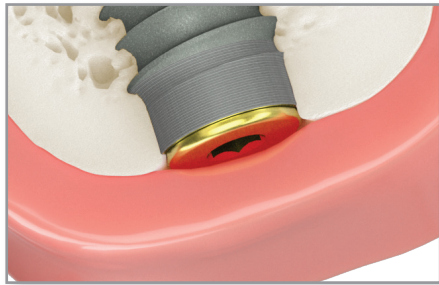

Implant with cover cap in a two-stage protocol.

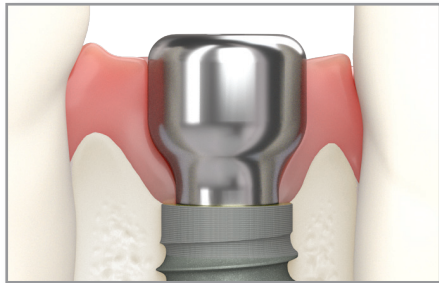

Implant with healing cap in a single-stage protocol.

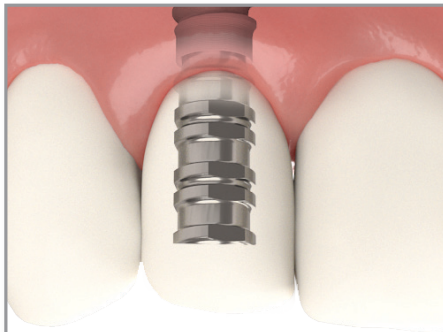

Implant restored with a non-functional provisional prosthesis.

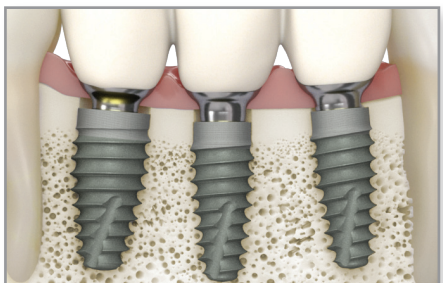

Implants with a splinted prosthesis in immediate function.

Two-Stage Protocol

In a two-stage surgery, the implant is placed below the soft tissue and protected from occlusal function and other forces during osseointegration. A low-profile cover cap is placed on the implant to protect it from the ingress of soft tissue.

Following osseointegration, a second procedure exposes the implant and a transmucosal healing cap is placed to allow for soft tissue healing and development of a sulcus. Prosthetic restoration begins after soft tissue healing.

Single-Stage Protocol

Single-stage surgery may be accomplished by placing a healing cap at the time of implant surgery. This eliminates the need for a second procedure. Although the implant is not in occlusal function, some forces can be transmitted to it through the exposed transmucosal element.

Prosthetic restoration begins following osseointegration of the implant and soft tissue healing.

Non-functional Immediate Restoration

Single-stage surgery with non-functional immediate provisionalization provides the patient a non-functioning provisional prosthesis early in the treatment plan. A temporary abutment is placed on the implant at or shortly after surgery, and a provisional restoration is secured using temporary cement. The provisional can help contour the soft tissue profile during healing.

Immediate Function Restoration

Single-stage surgery with immediate function is possible in good quality bone where multiple implants exhibiting excellent initial stability can be splinted together. Splinting implants together may offer a biomechanical advantage over individual, unsplinted prostheses.



Not intended for Tapered Short Conical implants.

Surgical Manual

Implant Placement Level & Spacing

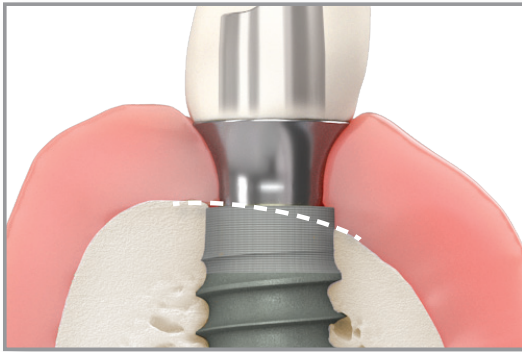

Placement in Uneven Ridges

When placing the implant in an uneven ridge, prepare the osteotomy and place the implant so the bone/soft-tissue junction is within the Laser-Lok transition zone. This will allow both soft tissue and bone to attach to the Laser-Lok collar. If the ridge discrepancy is more than the Laser-Lok transition zone, leveling the ridge can be considered.

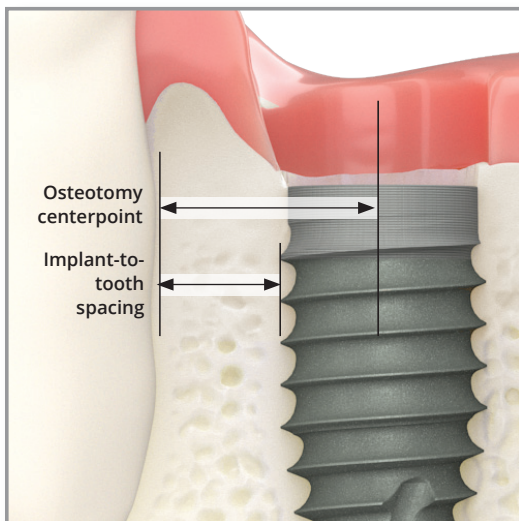

Implant-to-Tooth Spacing

The osteotomy centerpoint required to maintain a specific implant-to-tooth spacing is calculated according to this formula:

$1/2$ (implant body diameter) + the desired spacing.



During implant placement, clinicians must apply their best judgment as to the appropriate spacing for individual patient conditions.

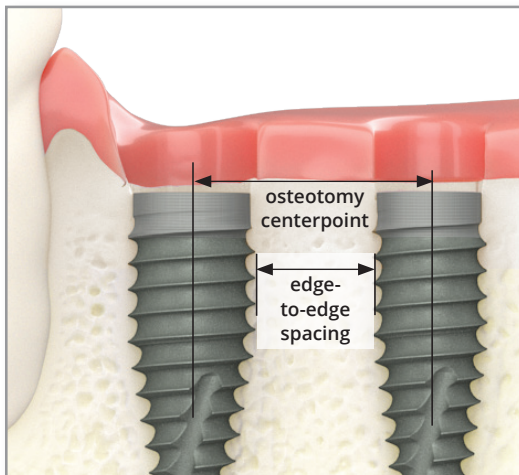

Implant-to-Implant Spacing

The osteotomy center-to-center measurement required to maintain a specific edge-to-edge spacing between two implants is calculated according to this formula:

$1/2$ (sum of 2 implant body diameters) + the desired spacing.



During implant placement, clinicians must apply their best judgment as to the appropriate spacing for individual patient conditions.

Surgical Manual

Surgical Kit & Drill Sequence

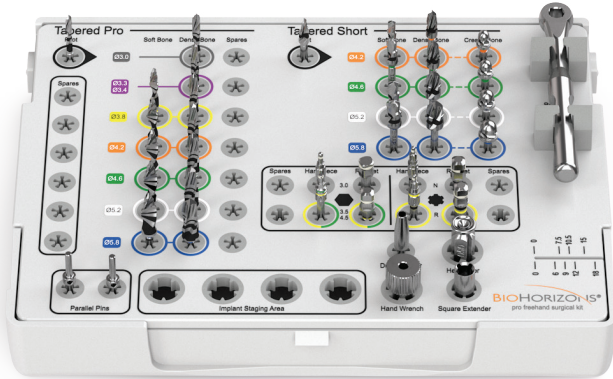

Surgical Kit Instructions

Prior to use, clean and sterilize the surgical tray and instruments according to the Instructions for Use. Study the surgical kit layout, color coding and iconography. Surgical assistants should be thoroughly familiar with all instruments and their uses prior to initiating the surgical procedure.

The surgical kit uses an intuitive layout to guide the surgeon through the instrument sequence. The sequence begins in the upper left hand corner and works left-to-right for each implant diameter.

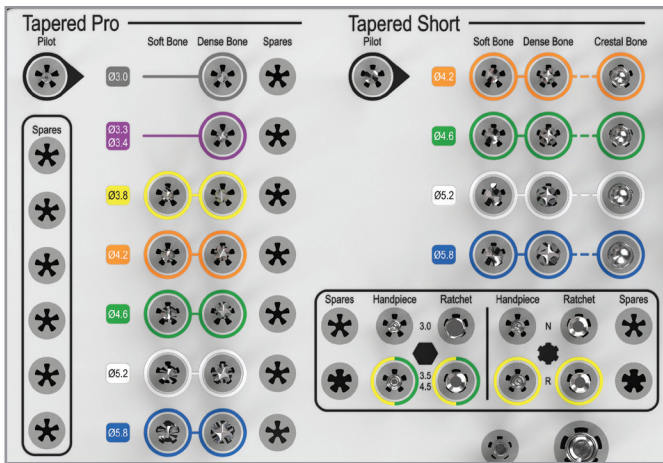

The freehand kit's drills increase in diameter as you work down the kit.

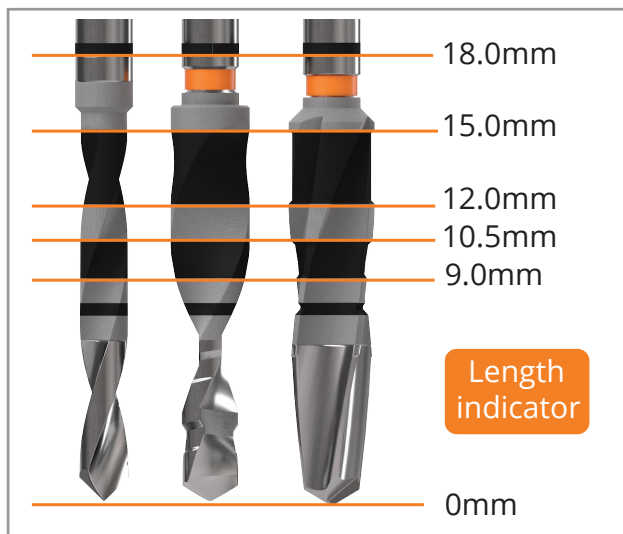

Drill Markings

All surgical drills included with this system are externally irrigated and designed to be used with steady sterile irrigation. Reduced drill speed may be indicated in softer bone or as drill diameter increases.

Note: The depth marks are consistent throughout all drills.

Surgical Manual

Osteotomy Initialization

Reduced Drill Sequence (4.2mm implant)

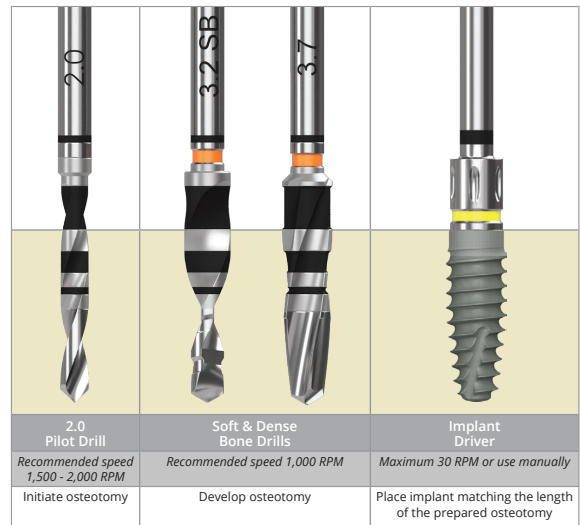
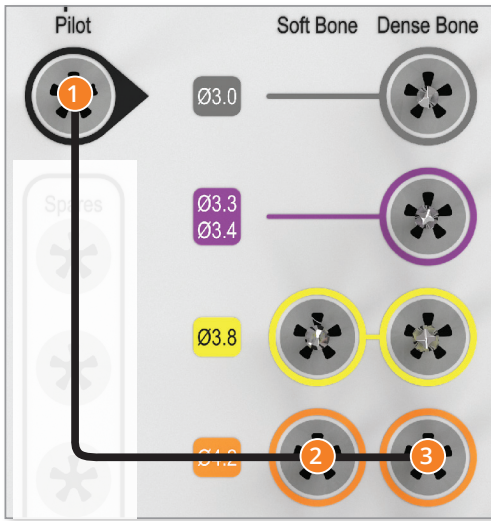

Using the **Reduced Protocol** allows the preparation of the osteotomy for implant placement by using two to three drills only.

- Study the surgical kit layout, color-coding and iconography of the kit.
- Initiate the osteotomy using the pilot drill. The pilot drill may also be used to set the depth of the osteotomy.
- Use the appropriate soft bone drill to prepare the recommended soft bone osteotomy.
- **Optional:** Use the appropriate dense bone drill for final revision and widening of the osteotomy in dense bone environment.

Conventional Drill Sequence (4.2mm implant)

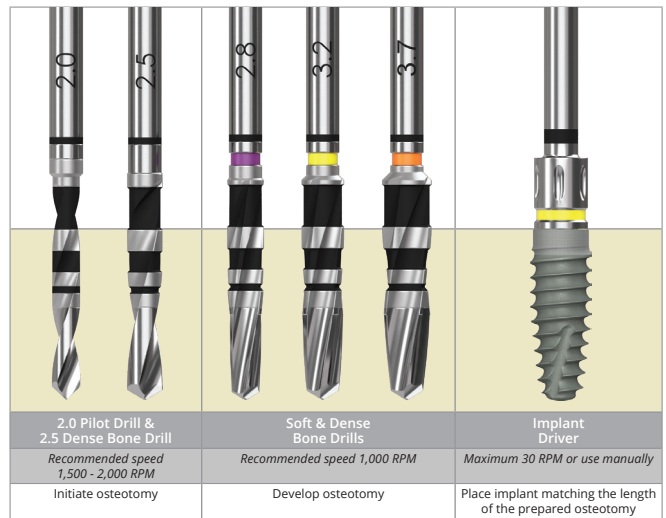
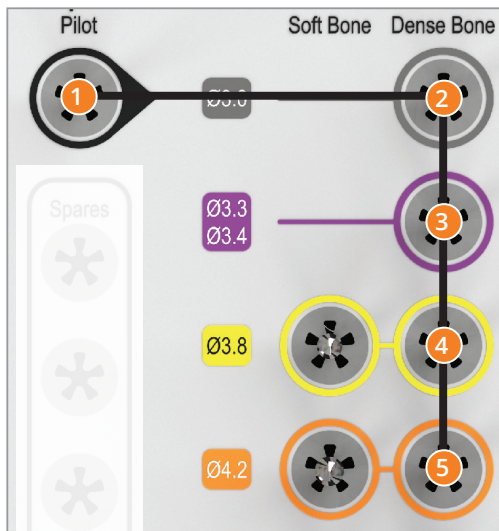

Using the **Conventional Protocol** allows the gradual preparation of the osteotomy for implant placement.

- Study the surgical kit layout, color-coding and iconography of the kit.
- Initiate the osteotomy using the pilot drill. The pilot drill may also be used to set the depth of the osteotomy.
- Use the dense bone drill dedicated for the 3.0mm diameter implant to widen the osteotomy and gradually work down the column of dense bone drills until the dense bone drill corresponding to the diameter of the implant being placed.
- **Under preparation of the osteotomy:** To under prepare the osteotomy, gradually work down the dense bone drill column and stop once the dense bone drill corresponding to a size smaller than the implant diameter is achieved.

Surgical Manual

Osteotomy Modification

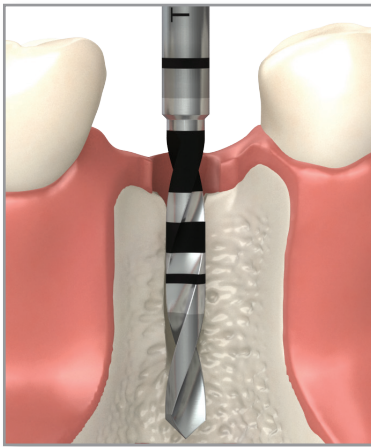

Pilot Drill

Purpose: Increase and/or set the depth of the osteotomy.

- Chisel-tip design eliminates “skating” on osseous crest
- Prepares site for paralleling pins
- Matte finish for increased visibility under operatory lights
- 1,500 - 2,000 RPM

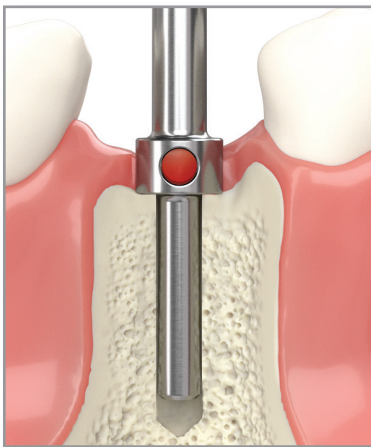

Paralleling Pins

Purpose: Evaluate osteotomy position and angle.

- Provided straight or with a 20° angle (*not included*)
- Use after 2.0mm Starter Drill
- 9mm shank for radiographic evaluation of proximity to adjacent anatomy
- Hub diameter is 4.0mm
- Pin diameter 2.0mm & 2.5mm

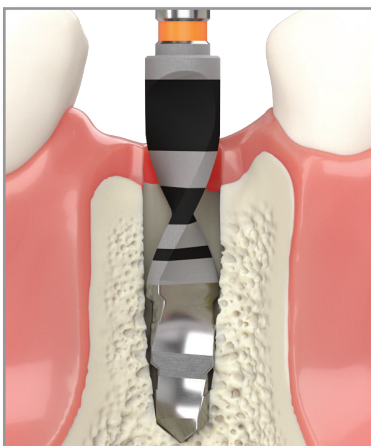

Soft Bone Drills

Purpose: Prepare recommended soft bone osteotomy

- Matte finish for increased visibility under operatory lights
- 1,000 RPM



Surgical Manual

Osteotomy Modification

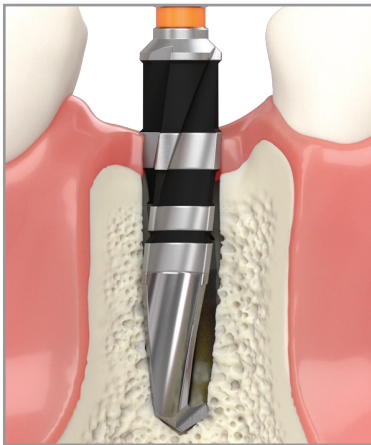

Dense Bone Drills (optional)

Purpose: For final revision and widening of the osteotomy in dense bone environment.

- Matte finish for increased visibility under operatory lights
- 1,000 RPM

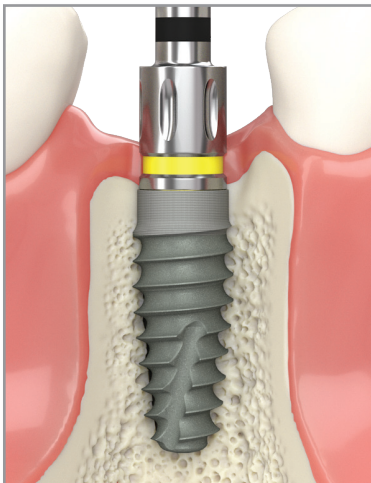

Implant Drivers

Purpose: Engage the implant's internal cams to drive implants into the osteotomy

- Conical implant drivers identified by a black laser-marked band
- Implant level drivers are color-coded by prosthetic connection:
 - Gray = Narrow platform
 - Yellow = Regular platform
- 30 rpm or less⁶

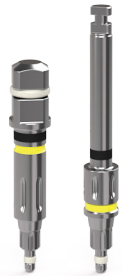

When placing a Tapered Pro Conical dental implant, the following insertion torque limits should not be exceeded:

- **117 Ncm** for conical implants containing a narrow connection
- **136 Ncm** for conical implants containing a regular connection

Surgical Manual

Implant Transfer



Implant Pick-up

To pick-up the implant, align the driver's cams with the implant's conical connection grooves and press firmly to engage the PEEK snap ring.

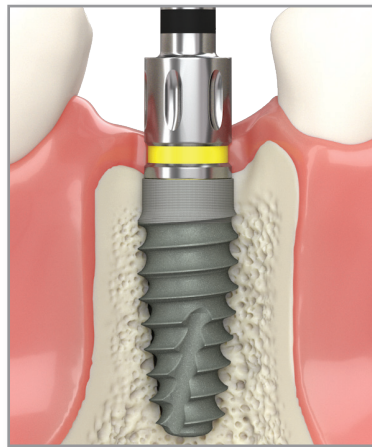
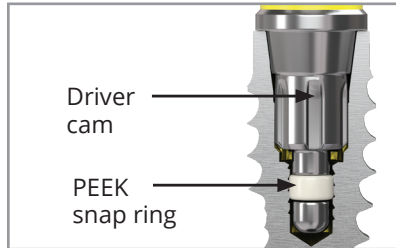

Implant Placement

Place the apex of the implant into the osteotomy and begin rotating slowly.



If too much resistance is felt during insertion, reverse the implant to relieve pressure and re-insert into the osteotomy. If the dense bone drill was not used while preparing the osteotomy, remove the implant and revise the osteotomy with the dense bone drill.

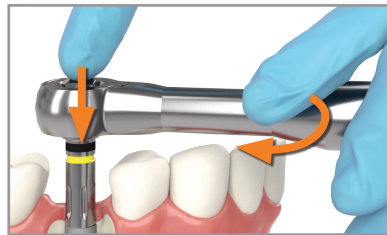

It is recommended to use both hands when placing the implant. One hand should be used to drive the implant, and the other should be used to stabilize the driver-implant connection.

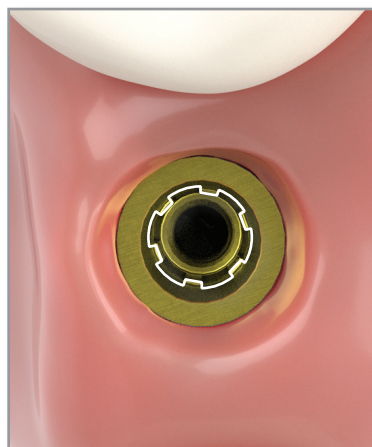

Implant Orientation

When seating the implant, use the corresponding dimples on the driver to orient them to match the position of the grooves on the implant connection. When reaching the planned intersection depth, one of the six grooves should face in a vestibular direction.

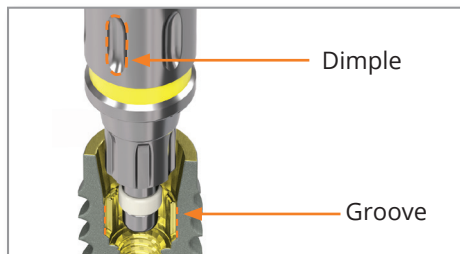

Surgical Manual

Tapered Short Conical Osteotomy Initialization

Tapered Short Conical Indications

BioHorizons Tapered Short Conical dental implants are intended for use in the mandible or maxilla as an artificial root structure for single tooth replacement or for fixed bridgework and dental retention. These dental implants must be restored using delayed loading, for single tooth replacement, or may be used with a terminal or intermediate abutment for fixed or removable bridgework or for overdentures. Tapered Short Conical implants should be used only when there is not enough space for a longer implant. If the ratio of crown length to implant length is unfavorable, the biomechanical risk factors have to be considered and appropriate measures have to be taken by the dental professional.

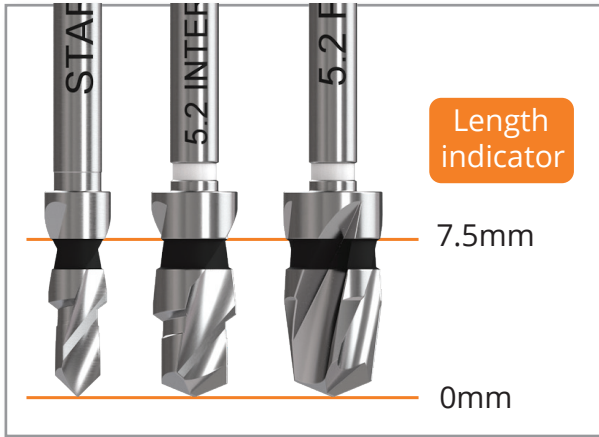

Drill Markings

All surgical drills included with this system are externally irrigated and designed to be used with steady sterile irrigation. Reduced drill speed may be indicated in softer bone or as drill diameter increases.

Note: The depth marks are consistent throughout all drills.

Drill Sequence (5.2mm short implant)

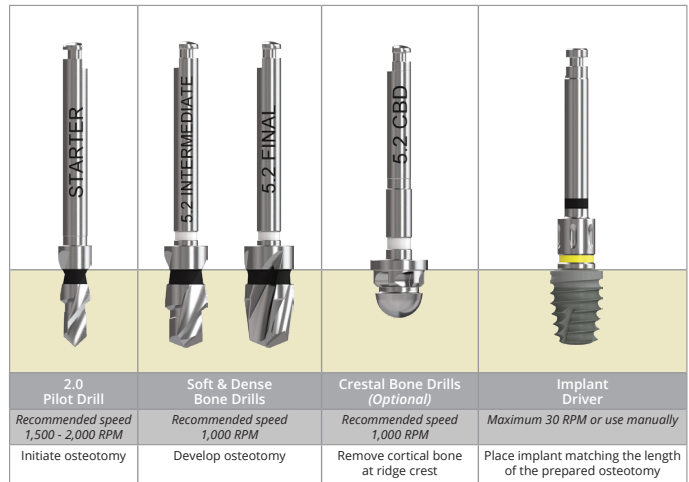
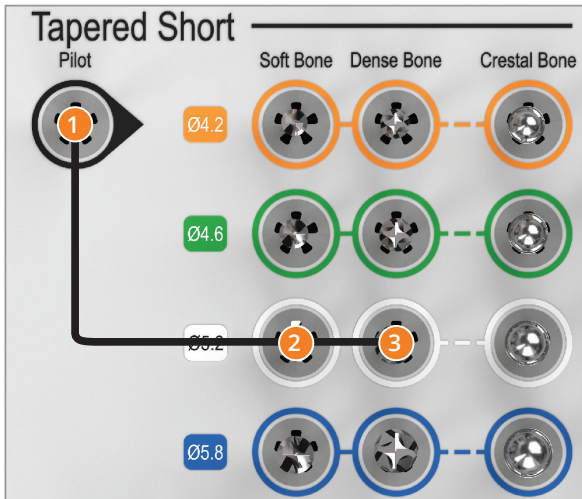

Using the **Reduced Protocol** allows the preparation of the osteotomy for implant placement by using two to three drills only.

- Study the surgical kit layout, color-coding and iconography of the kit.
- Initiate the osteotomy using the pilot drill. The pilot drill may also be used to set the depth of the osteotomy.
- Use the appropriate soft bone drill to prepare the recommended soft bone osteotomy.
- **Optional:** Use the appropriate dense bone drill for final revision and widening of the osteotomy in dense bone environment.

Surgical Manual

Tapered Short Conical Osteotomy Modification

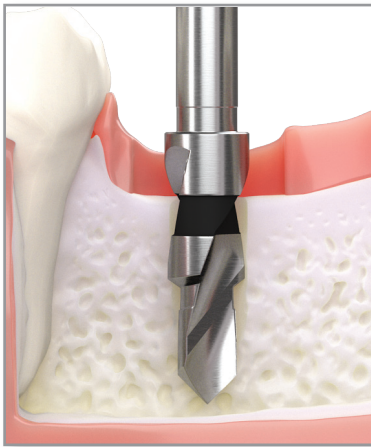

Pilot Drill

Purpose: Increase and/or set the depth of the osteotomy.

- Chisel-tip design eliminates “skating” on osseous crest
- 1,500 - 2,000 RPM

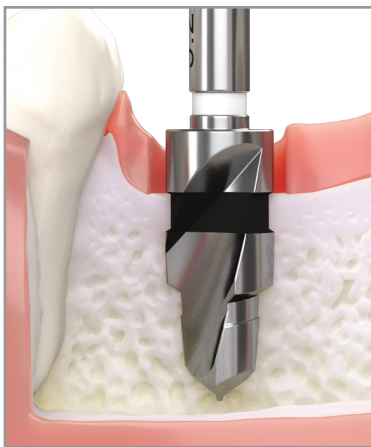

Soft Bone Drills

Purpose: Prepare recommended soft bone osteotomy

- 1,000 RPM



Dense Bone Drills

Purpose: For final revision and widening of the osteotomy in dense bone environment.

- 1,000 RPM



Surgical Manual

Tapered Short Conical Osteotomy Modification

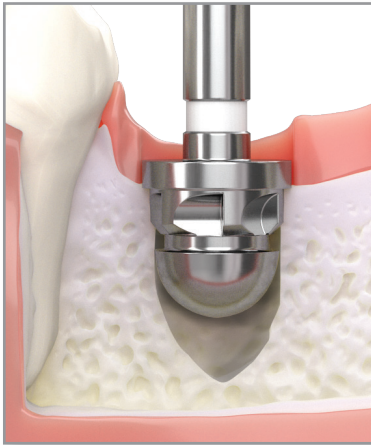

Crestal Bone Drills (optional)

Purpose: Remove cortical bone at ridge crest for pressure-free seating of the implant collar.

- Use when dense cortical bone is present at crest
- Rounded non-end cutting hub centers drill in osteotomy
- Use following the final drill for each implant
- 1,000 RPM

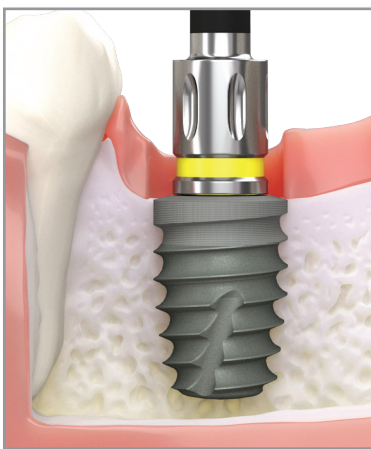

Implant Drivers

Purpose: Engage the implant's internal cams to drive implants into the osteotomy

- Conical implant drivers identified by a black laser-marked band
- Implant level drivers are color-coded by prosthetic connection:
 - Gray = Narrow platform
 - Yellow = Regular platform
- 30 rpm or less⁶

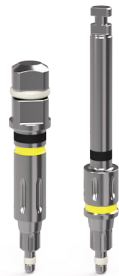

When placing a Tapered Short Conical dental implant, the following insertion torque limits should not be exceeded:

- **117 Ncm** for conical implants containing a narrow connection
- **136 Ncm** for conical implants containing a regular connection

Surgical Manual

Tapered Short Conical Implant Transfer



Implant Pick-up

To pick-up the implant, align the driver's cams with the implant's conical connection grooves and press firmly to engage the PEEK snap ring.

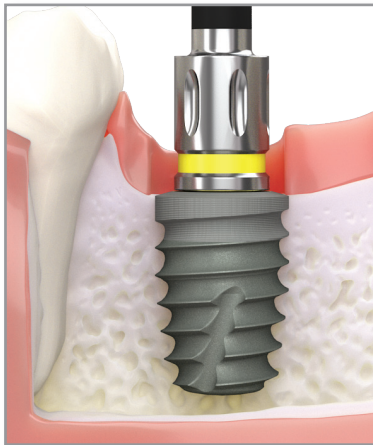
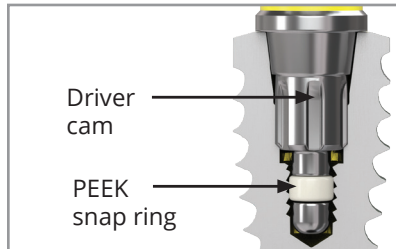

Implant Placement

Place the apex of the implant into the osteotomy and begin rotating slowly.



If too much resistance is felt during insertion, reverse the implant to relieve pressure and re-insert into the osteotomy. If the dense bone drill was not used while preparing the osteotomy, remove the implant and revise the osteotomy with the dense bone drill.



It is recommended to use both hands when placing the implant. One hand should be used to drive the implant, and the other should be used to stabilize the driver-implant connection.

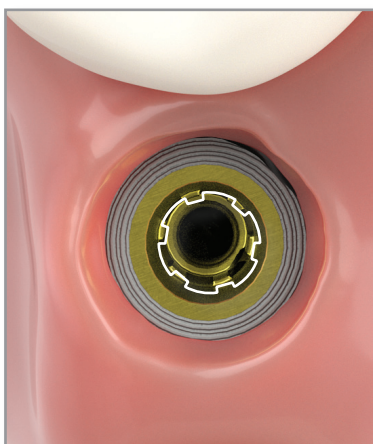

Implant Orientation

When seating the implant, use the corresponding dimples on the driver to orient them to match the position of the grooves on the implant connection. When reaching the planned intersection depth, one of the six grooves should face in a vestibular direction.

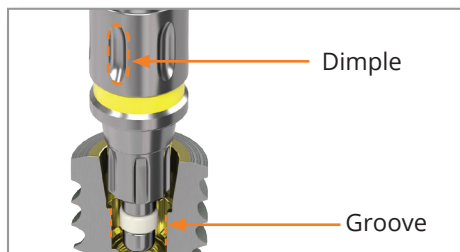

Surgical Manual

Healing Protocols

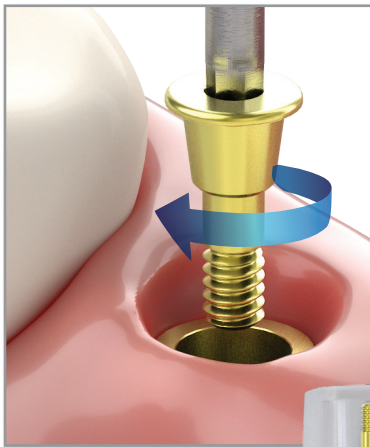

Cover Screws for Two-stage Protocol

Purpose: Protects prosthetic platform in two-stage (submerged) surgical protocol for bone level implants.

- Irrigate implant to remove blood and other debris:
- Use an antibacterial paste to decrease the risk of bacterial growth
- Thread clockwise into implant body
- Color-coded by prosthetic platform
- Hand-tighten (10-15 Ncm) utilizing .050" (1.25mm) Hex Driver

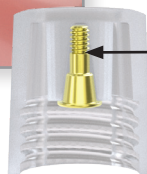

Cover screw

The cover screw for the implant is mounted in the vial cap.



Healing Caps for Single-stage Protocol

Purpose: Transmucosal element for developing soft tissue emergence with narrow, regular or wide emergence prosthetic components.

- Color-coded by prosthetic platform
- Hand-tighten (10-15 Ncm) utilizing .050" (1.25mm) Hex Driver



Immediate Provisional Restorative Options

Purpose: Titanium temporary abutments are easily modified for fabrication of cement or screw-retained provisional restorations.

- Not indicated for Short implants

Surgical Manual

Appendix

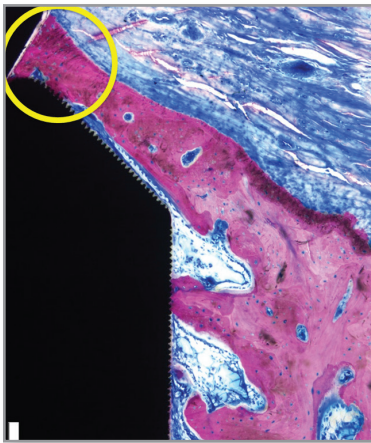
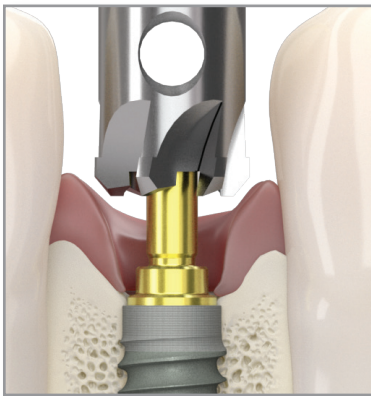

Image showing exceptional bone growth at 3 months. (Myron Nevins, DDS.)



Bone Profilers

Purpose: In cases where excess crestal bone has been created, use a bone profiler at implant uncover to contour the bone. This will provide the necessary clearance for proper abutment seating.

- Profiler guide protects implant platform
- Color-coded by prosthetic platform (gray=narrow, yellow=regular)
- 800 rpm drill speed with steady sterile irrigation



Do not use the profiler without the guide in place.

Using an .050" hex driver, remove the surgical cover cap from the implant and place the profiler guide that matches the color of the prosthetic platform. Use the profiler with copious amounts of sterile irrigation. Once the excess bone and soft tissue are removed, unscrew the guide and seat the appropriate prosthetic component.

Post-operative Instructions

A period of unloaded healing time is often recommended to allow for integration between the bone and implant surface. This is dependent on individual patient healing rates and bone quality of the implant site. Each case must be independently evaluated.

The patient should be instructed to follow a post-surgical regimen including cold packs for 24 hours post-implantation. The patient's diet should consist of soft foods and possibly dietary supplements. Pharmacological therapy should be considered as the patient's condition dictates.

If a removable prosthesis is used during the initial healing phase, a soft liner material should be used to prevent pressure on the surgical site. Relieve the prosthesis over the implant site prior to the soft liner application. Periodically check the patient's soft tissue and bone healing using clinical and radiographic evaluations.

Ongoing hygiene for the implant patient is vital. Hygiene recall appointments at three month intervals are suggested. Instruments designed for implant abutment scaling, such as ImplanCare® instruments from Hu-Friedy® should be utilized. The stainless steel handles may be fitted with assorted tip designs for hygiene on natural teeth. The ImplanCare® scalers contain no glass or graphite fillers that can scratch titanium implant abutments.

Surgical Manual

Icon Legend

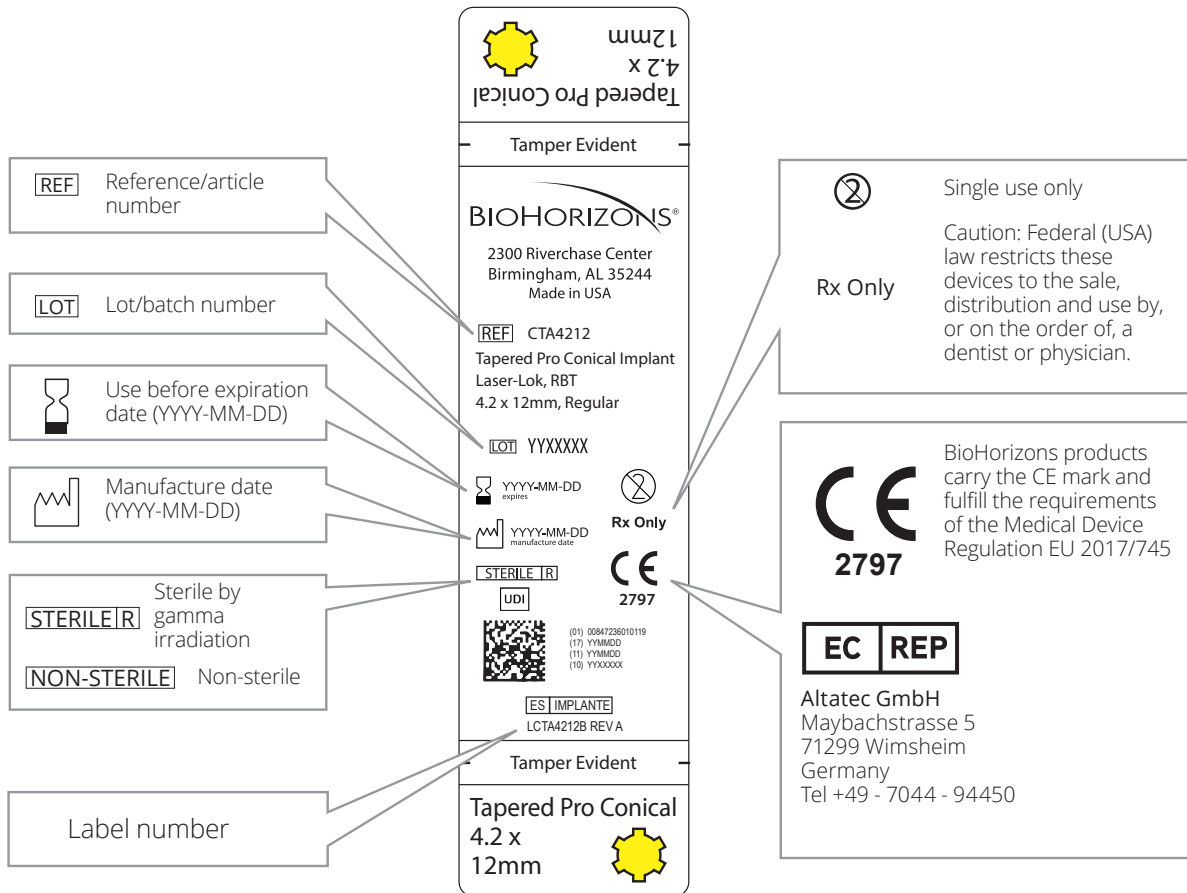

Symbol Descriptions for Product Labeling

The example labeling below is to demonstrate content and symbology, and may differ on individual product labeling.



Tapered Pro Conical Product Labeling



body diameter	prosthetic platform
3.3mm	 narrow
3.8mm	
4.2mm	 regular
4.6mm	
5.2mm	

Ordering & Warranty Information

BioHorizons Lifetime Warranty on Implants and Prosthetics for Clinicians: All BioHorizons implants and prosthetic components include a Lifetime Warranty. BioHorizons implant or prosthetic components will be replaced if removal of that product is due to failure (excluding normal wear to overdenture attachments).

Additional Warranties: BioHorizons warranties surgical drills, taps and other surgical and restorative instruments.

(1) Surgical Drills and Taps: Surgical drills and taps include a warranty period of ninety (90) days from the date of initial invoice. Surgical instruments should be replaced when they become worn, dull, corroded or in any way compromised. Surgical drills should be replaced after 12 to 20 osteotomies.⁵

(2) Instruments: The BioHorizons manufactured instrument warranty extends for a period of one (1) year from the date of initial invoice. Instruments include drivers, implant site dilators and BioHorizons tools used in the placement or restoration of BioHorizons implants.

Return Policy: Product returns require a Return Authorization Form, which may be acquired by contacting Customer Care. The completed Return Authorization Form must be included with the returned product. For more information, please see the reverse side of the invoice that was shipped with the product.

Disclaimer of Liability: BioHorizons products may only be used in conjunction with the associated original components and instruments according to the Instructions for Use (IFU). Use of any non-BioHorizons products in conjunction with BioHorizons products will void any warranty or any other obligation, expressed or implied.

Treatment planning and clinical application of BioHorizons products are the responsibility of each individual clinician. BioHorizons strongly recommends completion of postgraduate dental implant education and adherence to the IFU that accompany each product. BioHorizons is not responsible for incidental or consequential damages or liability relating to use of our products alone or in combination with other products other than replacement or repair under our warranties.

Distributed Products: For information on the manufacturer's warranty of distributed products, please refer to their product packaging. Distributed products are subject to price change without notice.

Validity: Upon its release, this literature supersedes all previously published versions.

Availability: Not all products shown or described in this literature are available in all countries. BioHorizons continually strives to improve its products and therefore reserves the right to improve, modify, change specifications or discontinue products at any time.

Any images depicted in this literature are not to scale, nor are all products depicted. Product descriptions have been modified for presentation purposes. For complete product descriptions and additional information, visit store.biohorizons.com.

References

1. Semper-Hogg, W, Kraft, S, Stiller, S et al. Analytical and experimental position stability of the abutment in different dental implant systems with a conical implant-abutment connection *Clin Oral Invest* (2013) 17: 1017
2. Semper Hogg W, Zulauf K, Mehrhof J, Nelson K. The influence of torque tightening on the position stability of the abutment in conical implant-abutment connections. *Int J Prosthodont* 2015;28:538-41
3. Ackermann KL, et al. Clinical and patient-reported outcome of implant restorations with internal conical connection in daily dental practices: prospective observational multicenter trial with up to 7-year follow-up. *International Journal of Implant Dentistry*. 2020 Apr 8;6(1):14.
4. The influence of 0.12 percent chlorhexidine digluconate rinses on the incidence of infectious complications and implant success. Lambert PM, Morris HF, Ochi S. *J Oral Maxillofac Surg*. 1997;55(12 supplement 5):25-30. R10021c
5. Heat production by 3 implant drill systems after repeated drilling and sterilization. Chacon GE, Bower DL, Larsen PE, McGlumphy EA, Beck FM. *J Oral Maxillofac Surg*. 2006 Feb;64(2):265-9. R30003b
6. Root Form Surgery in the Edentulous Mandible: Stage I Implant Insertion. CE Misch. *Contemporary Implant Dentistry Second Edition*. Mosby: St. Louis, 1999. 347-369.

Direct Offices

BioHorizons USA
888-246-8338 or 205-967-7880

BioHorizons Canada
866-468-8338

BioHorizons Spain
+34 91 713 10 84

BioHorizons UK
+44 (0)1344 752560

BioHorizons Chile
+56 (2) 23619519

BioHorizons Italy
800-063-040

BioHorizons Mexico
800-953-0498

Distributors

For contact information in our 90 countries, visit biohorizons.com



shop online at
store.biohorizons.com

BioHorizons®, Laser-Lok®, MinerOss®, AutoTac®, Mem-Lok®, TeethXpress®, IntraSpin®, L-PRF® and Xpression® are registered trademarks of BioHorizons Implant Systems Inc. Genate™ is a trademark of BioHorizons. Unigrip™ is a trademark of Nobel Biocare AB. Zimmer® Dental ScrewVent® and Tapered ScrewVent® are registered trademarks of Zimmer, Inc. AlloDerm SELECT™, AlloDerm SELECT GBR™ and NovoMatrix™ are trademarks of Allergan, an AbbVie company. Grafton® DBM is a registered trademark of Medtronic, Inc. Cytoplast® is a registered trademark of Osteogenics Biomedical, Inc. Puros Dermis is a registered trademark of Zimmer Biomet. Mucograft is a registered trademark of Ed. Geistlich Sogne Ag Fur Chemische Industrie. Symbios PerioDerm is a registered trademark of Dentsply Sirona. Hu-Friedy® is a registered trademark of Hu-Friedy Mfg. Co., LLC. Spiralock® is a registered trademark of Spiralock Corporation. Pomalux® is a registered trademark of Westlake Plastics Co. Locator® is a registered trademark of Zest Anchors, Inc. Delrin® is a registered trademark of E.I. du Pont de Nemours and Company. Bio-Gide® is a registered trademark of Edward Geistlich Sohne AG Fur Chemische Industrie. BioMend® is a registered trademark of Zimmer Biomet Dental. Not all products shown or described in this literature are available in all countries. We are proud to be registered to ISO 13485:2016, the international quality management system standard for medical devices, which supports and maintains our product licences with Health Canada and in other markets around the globe. Original language is English. ©BioHorizons Implant Systems Inc. All Rights Reserved.



L02091



REV D NOV 2024