

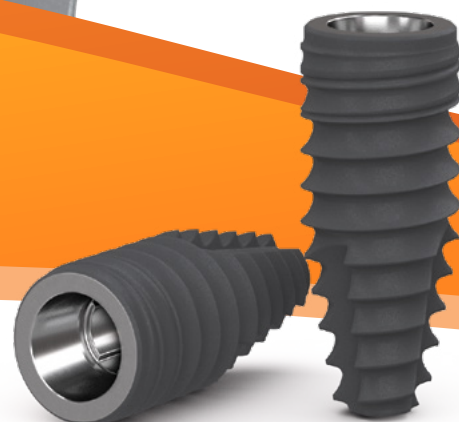

**CONELOG®**  
**PROGRESSIVE**  
implant system

Catalog & Surgical Manual



**BIOHORIZONS®**

# CONELOG® PROGRESSIVE-LINE

## product information & ordering

The CONELOG® PROGRESSIVE-LINE Implant System is based on many years of experience with the SCREW-LINE implant design as well as comprehensive laboratory tests. The CONELOG® PROGRESSIVE-LINE Implant System is a user-friendly, and prosthetically oriented implant system.

The CONELOG® and CAMLOG® Implant Systems are well documented scientifically. Studies support this with respect to many parameters including the implant surface, time of implantation and/or implant loading, primary stability, and the connection design.

CONELOG® PROGRESSIVE-LINE implants are endosseous implants available in various lengths and diameters. They are surgically inserted in the bone of the maxilla and/or mandible and serve as an anchor for functional and esthetic restorations for partially and fully edentulous patients. The prosthetic restoration is performed with single crowns, bridges or full dentures that are attached to the CONELOG® PROGRESSIVE-LINE implants with the appropriate CONELOG® components.

CONELOG® PROGRESSIVE-LINE implants were developed to facilitate the implementation of modern treatment concepts such as immediate restoration or loading, which require high primary stability.

The CONELOG® PROGRESSIVE-LINE implants are not only suitable for delayed surgery, but also for immediate or delayed immediate surgery in maxillary and/or mandibular bone. The selected healing technique can be either submerged or transgingival. In the case of a one-stage surgical procedure, the implants can be loaded immediately if good primary stability has been achieved and functional loading is appropriate.

A deeper coronal implant shoulder is especially beneficial in treating esthetically challenging areas. <sup>1</sup> The CONELOG® PROGRESSIVE-LINE Promote® Plus implant, which can be placed both epicrestally as well as subcrestally, is suited for this situation. <sup>2</sup>

## General information

This surgical manual serves as a reference for using the CONELOG® PROGRESSIVE-LINE implants and surgical instruments according to the Flex protocol. It is intended solely to provide instructions on the use of BioHorizons Camlog products. It is not intended to describe the methods or procedures for diagnosis, treatment planning, or placement of implants, nor does it replace clinical training or a clinician's best judgment regarding the needs of each patient.

BioHorizons Camlog strongly recommends appropriate training as a prerequisite for the placement of implants and associated treatment.

The procedures illustrated and described within this manual reflect idealized patient presentations with adequate bone and soft tissue to accommodate implant placement. No attempt has been made to cover the wide range of actual patient conditions that may adversely affect surgical and prosthetic outcomes. Clinician judgment as related to any specific case must always supersede any recommendations made in this or any BioHorizons Camlog literature.

Before beginning any implant surgical procedure with BioHorizons Camlog implants:

- Read and understand the Instructions for Use that accompany the products.
- Clean and sterilize the surgical tray and instruments per Instructions for Use.
- Become thoroughly familiar with all instruments and their uses.
- Study surgical kit layout and iconography.
- Design a surgical treatment.

**Please note this manual is for CONELOG® PROGRESSIVE-LINE implants and the Flex instrument protocol. Descriptions may be abbreviated throughout for ease of reading.**

# Table of contents

<b>GENERAL INFORMATION</b>	<b>INSIDE COVER</b>
<b>CONELOG® PROGRESSIVE IMPLANT SYSTEM</b>	<b>2-3</b>
<b>CONELOG® PROGRESSIVE IMPLANTS</b>	<b>4</b>
Surgical instruments - implant bed preparation	5
Surgical instruments - miscellaneous	6-7
Healing caps & cover screws	8
<b>IMPLANT POSITION PLANNING</b>	<b>9</b>
Leverage ratio on implant	9
Distances to adjacent structures	9
Design of prosthetic restorations	10
Kit layout - drivers & instruments	10
<b>SURGICAL PROCEDURE</b>	<b>11</b>
Standard & soft bone drilling sequence	11-13
Packaging and implant handling	14-15
Insertion tools	16-17
Drilling sequence	18-20
Opening of the package (implant delivery)	21-28
Healing options	29-31
Loading protocols	32
<b>Further documentation</b>	<b>33</b>

# CONELOG®

## PROGRESSIVE-LINE



## conical performance at bone level

### CONELOG® connection benefits

- long conus for reduced micromovements <sup>3</sup>
- superior positional stability in comparison to other conical systems <sup>3,4</sup>
- easy positioning with tactile feedback
- integrated platform switching
- "vertical fit feature" designed to minimize vertical discrepancy during workflow



Flexible solutions - full range of prosthetic components serving all prosthetic indications and treatment concepts

Digital workflow - from planning to guided surgery and prosthetic restoration

Integrated platform switching

Tapered body with buttress thread design and coronal anchoring thread for primary stability

Promote® surface - for predictable longterm success outstanding clinical longterm results and comprehensive scientific documentation <sup>5</sup>

Diameter-reduced implants (Ø 3.3 mm) and a short implant length (L 7 mm) extend the range of indications

## surgical kit features:

- Compact tray design with all the required instruments for soft and dense bone protocols
- Efficient color-coded surgical sequence
- Validated for automated cleaning, disinfection and sterilization
- Empty spare slots allow for customization



**CONELOG®**  
**PROGRESSIVE-LINE**

shop online at [store.biohorizons.com](http://store.biohorizons.com)



# CONOLOG® PROGRESSIVE implants

Snap-in and Screw-mounted insertion post

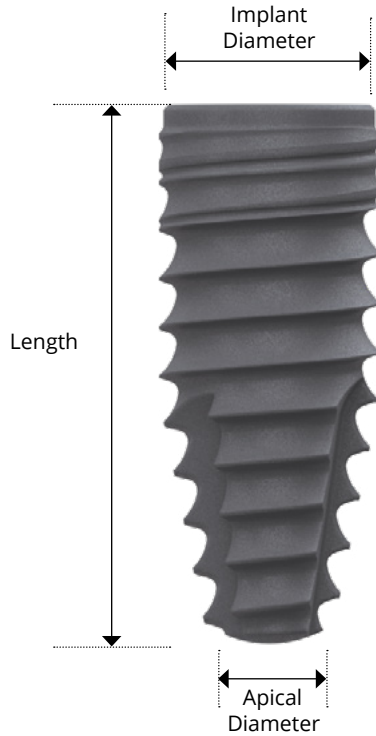

## CONOLOG® PROGRESSIVE-LINE implant, Promote® Plus

Includes insertion post (snap-in or screw-mounted) and cover screw.  
Packaged sterile. Titanium Grade 4.

Snap-in Part Number	Screw-mounted Part Number	Implant Diameter	Length	Apical Diameter
C1086.3309	C1085.3309	3.3 mm	9 mm	2.2 mm
C1086.3311	C1085.3311		11 mm	
C1086.3313	C1085.3313		13 mm	
C1086.3316	C1085.3316		16 mm	
C1086.3807	C1085.3807	3.8 mm	7 mm	3.0 mm
C1086.3809	C1085.3809		9 mm	
C1086.3811	C1085.3811		11 mm	2.7 mm
C1086.3813	C1085.3813		13 mm	
C1086.3816	C1085.3816	4.3 mm	16 mm	3.0 mm
C1086.4307	C1085.4307		7 mm	
C1086.4309	C1085.4309		9 mm	
C1086.4311	C1085.4311		11 mm	
C1086.4313	C1085.4313	13 mm		
C1086.4316	C1085.4316	16 mm		
C1086.5007	C1085.5007	5.0 mm	7 mm	3.5 mm
C1086.5009	C1085.5009		9 mm	
C1086.5011	C1085.5011		11 mm	3.2 mm
C1086.5013	C1085.5013		13 mm	
C1086.5016	C1085.5016	16 mm		

## Surgery set

CONOLOG® PROGRESSIVE



**J5300.0071**

**CONOLOG® PROGRESSIVE-LINE Flex Surgery set**

Includes the instrumentation required to place:  
CONOLOG® PROGRESSIVE according to the Flex protocol



**J5300.8920**

**CONOLOG® PROGRESSIVE-LINE Flex Surgery tray**

Empty tray without instruments

# Surgical instruments

## Implant bed preparation

### Gingiva punches\*

Packaged sterile. Stainless steel.



Part Number	Diameter
J5041.3304	3.3 mm
J5041.3804	3.8 mm
J5041.4304	4.3 mm
J5041.5004	5.0 mm

### J5051.2000 Pilot drill

Resterilizable. Stainless steel.  
2.0 mm diameter.



### Profile drills, PROGRESSIVE-LINE Flex

Resterilizable. Stainless steel.



Part Number	Diameter
J5080.3300	3.3 mm
J5080.3800	3.8 mm
J5080.4300	4.3 mm
J5080.5000	5.0 mm

### Taps, PROGRESSIVE-LINE\*

Resterilizable. Stainless steel.



Part Number	Diameter
J5071.3300	3.3 mm
J5071.3800	3.8 mm
J5071.4300	4.3 mm
J5071.5000	5.0 mm

### Guide pins for bone profilers\*

Titanium alloy.



Part Number	Diameter
C5002.3300	3.3 mm
C5002.3800	3.8 mm
C5002.4300	4.3 mm
C5002.5000	5.0 mm



### J5050.2300 Round bur

Resterilizable. Stainless steel.  
2.3 mm diameter.

### Drills, PROGRESSIVE-LINE Flex

Resterilizable. Stainless steel.



Part Number	Diameter
J5079.3300	3.3 mm
J5079.3800	3.8 mm
J5079.4300	4.3 mm
J5079.5000	5.0 mm

### Dense bone drills, PROGRESSIVE-LINE

Resterilizable. Stainless steel.



Part Number	Diameter
J5072.3300	3.3 mm
J5072.3800	3.8 mm
J5072.4300	4.3 mm
J5072.5000	5.0 mm

### Bone profilers\*

Resterilizable. Stainless steel.



Part Number	Diameter
J5003.3350	3.3 mm
J5003.4360	3.8 mm
J5003.4360	4.3 mm
J5003.5070	5.0 mm

### J5300.0022 Removal adapter

Suitable for all implant diameters  
(3.3, 3.8, 4.3 and 5.0 mm). Stainless steel.



\* These instruments are not included in the CONELOG® PROGRESSIVE-LINE Flex Surgery Set and must be ordered separately.

# Surgical instruments

## Miscellaneous



**J5300.2000**

**Parallel pin**

Depth marks align with 2.0 mm pilot drill markings. Titanium alloy.



**J5300.0031**

**Driver, extra short\***

Manual/wrench for screw implants, 13.7 mm length. Stainless steel.



**J5300.0032**

**Driver, short\***

Manual/wrench for screw implants, 19.2 mm length. Stainless steel.



**J5300.0033**

**Driver, long**

Manual/wrench for screw implants, 24.8 mm length. Stainless steel.



**J5300.0036**

**Driver, short**

With ISO-shaft for angled hand piece (without hexagon at the shaft). For screw implants. 19.1 mm length. Stainless steel.



**J5300.0037**

**Driver, long\***

With ISO-shaft for angled hand piece (without a hexagon on the shaft). For screw implants. 28.2 mm length. Stainless steel.



**J5300.0030**

**Pick-up instrument\***

Holder for carrying implants. Stainless steel. Only for use with CONELOG® PROGRESSIVE implants with Art.-No. C1086.xxxx



**J5002.0006**

**Drill extender**

Drill extension, ISO shaft. 26.5 mm length. Resterilizable. Stainless steel.

\* These instruments are not included in the CONELOG® PROGRESSIVE-LINE Flex Surgery Set and must be ordered separately.



# Surgical instruments

## Miscellaneous (continued)

### CONELOG® Implant adapters, short\*

Screw-retained implant driver, short.  
28.1 mm length. Stainless steel.



Part Number	Diameter
C5302.3311	3.3 mm
C5302.4311	3.8 mm
	4.3 mm
C5302.5011	5.0 mm

### CONELOG® Implant adapters, long\*

Screw-retained implant driver, long.  
33.1 mm length. Stainless steel.



Part Number	Diameter
C5302.3310	3.3 mm
C5302.4310	3.8 mm
	4.3 mm

### Holding sleeves\*

For screw implants. Color-coded.  
Stainless steel.



Part Number	Diameter
J5302.3300	3.3 mm
J5302.3800	3.8 mm
J5302.4300	4.3 mm
J5302.5000	5.0 mm



### J5002.0013 Ratchet Adapter

ISO-shaft for angled hand piece.  
21 mm length. Stainless steel.



### J5317.0504 Screwdriver, short

Hex, short, ISO shaft.  
18 mm length. Stainless steel.



### J5317.0503 Screwdriver, long\*

Hex, long, ISO shaft.  
26 mm length. Stainless steel.



### J5320.1030 Torque wrench

With continuous torque adjustment.  
Maximum torque 30 Ncm.  
Stainless steel.





### J5302.0010 Holding key for insertion post

Stainless steel.

\* These instruments are not included in the CONELOG® PROGRESSIVE-LINE Flex Surgery Set and must be ordered separately.

# Healing caps

## One-stage protocol

	Part Number	Description	Diameter	Gingival Height	Gingival Diameter
	C2015.3320	<b>CONOLOG® Healing caps, cylindrical sterile</b>  <b>Material</b> Titanium alloy	3.3 mm	2.0 mm	3.0 mm
	C2015.3340			4.0 mm	3.0 mm
	C2015.3820		3.8 mm	2.0 mm	3.5 mm
	C2015.3840			4.0 mm	3.5 mm
	C2015.3860*		6.0 mm	3.5 mm	
	C2015.4320		4.3 mm	2.0 mm	3.8 mm
	C2015.4340			4.0 mm	3.8 mm
	C2015.4360*			6.0 mm	3.8 mm
	C2015.5020		5.0 mm	2.0 mm	4.5 mm
	C2015.5040			4.0 mm	4.5 mm
	C2015.5060*			6.0 mm	4.5 mm
	C2014.3340	<b>CONOLOG® Healing caps, wide body sterile</b>  <b>Material</b> Titanium alloy	3.3 mm	4.0 mm	4.8 mm
	C2014.3840		3.8 mm	4.0 mm	5.3 mm
	C2014.3860			6.0 mm	5.3 mm
	C2014.4340		4.3 mm	4.0 mm	5.8 mm
	C2014.4360			6.0 mm	5.8 mm
	C2014.5040			5.0 mm	4.0 mm
	C2014.5060		6.0 mm		6.5 mm
	C2011.3340	<b>CONOLOG® Healing caps, bottleneck sterile</b>  <b>Material</b> Titanium alloy	3.3 mm	4.0 mm	3.3 mm
	C2011.3840		3.8 mm	4.0 mm	3.8 mm
	C2011.3860			6.0 mm	3.8 mm
	C2011.4340		4.3 mm	4.0 mm	4.0 mm
	C2011.4360			6.0 mm	4.0 mm
	C2011.5040			5.0 mm	4.0 mm
	C2011.5060		6.0 mm		4.7 mm

\* Suitable for bite registration

# Cover screws

## two-stage protocol

### CONOLOG® Cover screw

Color-coded. Titanium alloy.



Part Number	Diameter
C2019.3300	3.3 mm
C2019.3800	3.8 mm
C2019.4300	4.3 mm
C2019.5000	5.0 mm

# Implant position planning

Implant treatment should be planned by the team and be based on the desired prosthetic outcome. The following aspects should be taken into account during planning:

## Leverage ratio on implant

The loading of the implant-bone interface is determined by the leverage ratio from the osseointegration-related resistance to the prosthetic load arm (equal to the supracrestal implant length plus crown length from the implant shoulder). If the implant length (IL) is less than the length of the crown (CL), measures must be taken to reduce loading (e.g. using prosthetic splints). If leverage ratios on the implant are unfavorable, a longer implant must be selected.

The ratio of crown length (CL) to implant length (IL) should be 0.8:1 maximum. Implant distribution should be structured in such a way that spanned segments are kept small. Preparation of the abutment must ensure the common insertion direction of the crown block/bridges. The implant-abutment connection may not be altered.

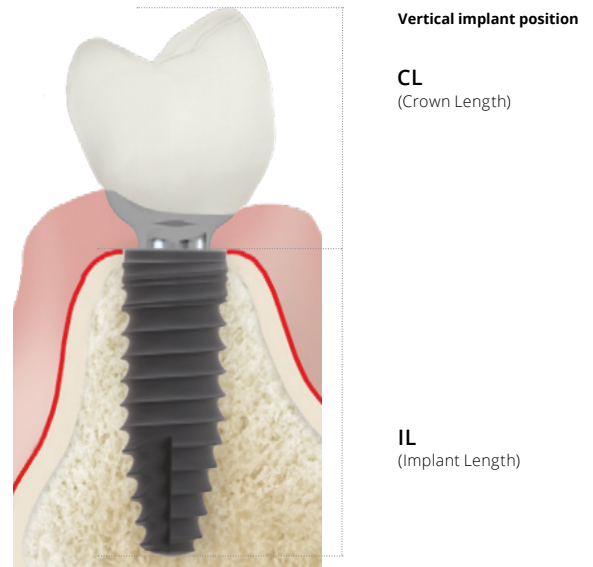

## Distances to adjacent structures

### Vertical implant position

The recommendations for the distances to be maintained from adjacent structures must be observed to allow wound healing to proceed optimally and for hard and soft tissue to develop optimally during the healing phase.

The recommended distances for determining the vertical implant position are shown in the diagram. These must be adapted to the clinical situation.

The implant length must be sized to leave adequate bone (at least 1 mm) around the implant.

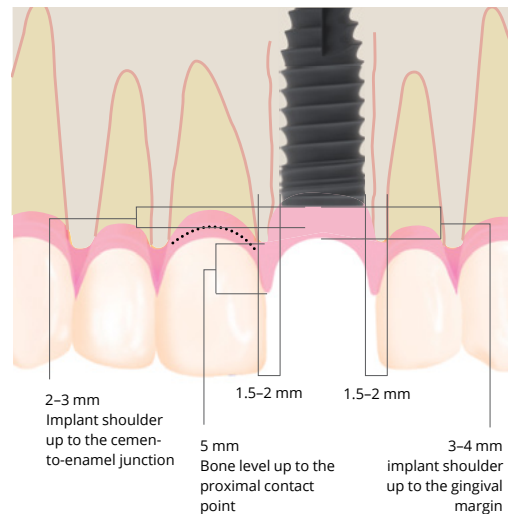

### Horizontal implant position

Maintain a minimum distance of 1.5 mm to an adjacent natural tooth and 3 mm to an adjacent implant.

The implant diameter must be sized to leave adequate bone (at least 1 mm) around the implant.

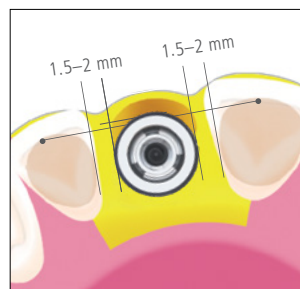

Mesiodistal implant position at bone level

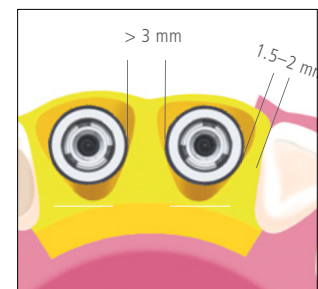

Distances at bone level

# Implant position planning

## Bar restorations on two implants

Restoration of an edentulous mandible with two implants presents the minimum restoration, where the possibility of release of the implants should be taken into consideration during the prosthetic planning. This can be achieved by the use of prosthetic restorations which allow rotation, for example ball abutments, Locator® abutments or a bar restoration with a round profile.

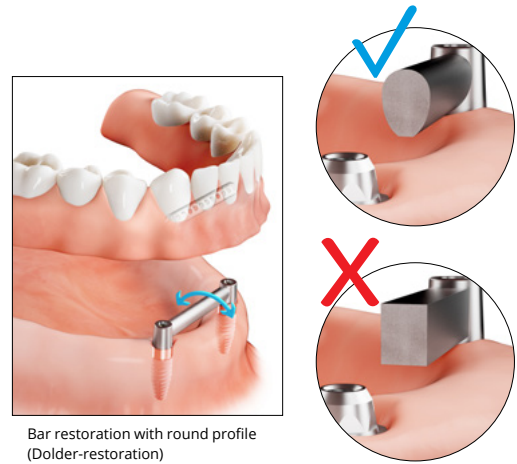

Bar restoration with round profile (Dolder-restoration)

## Design of prosthetic restorations

Irrespective of the type of restoration - fixed single crowns, splinted crowns, bridges or removable restorations - the hygiene capability of the restoration should be taken into account.

In the case of hybrid restorations, we recommend designing the prosthetics to fit passively. The tension-free seating of a secondary (double crown) or primary (bar) splinted structure on implants is regarded as «Passive Fit».

In the case of double crown restorations, this is obtained through intraoral bonding of the secondary crowns (preferably galvano crowns) onto the tertiary framework. In the case of bar structures, it involves the use of bar sleeves for a «Passive Fit» and intraoral bonding of the titanium bonding base. The idea is to create a fit that is free from stress or to minimize stress on the implants.

When planning a removable denture, the implants should be placed to allow for a fixed restoration in future, if necessary.

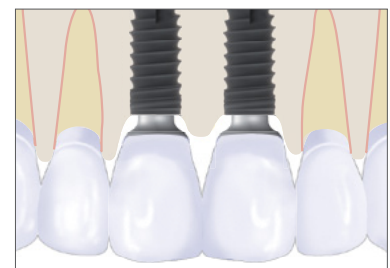

Single-crown restoration



Cement-retained bridge

# CONOLOG® PROGRESSIVE

## Drivers & instruments

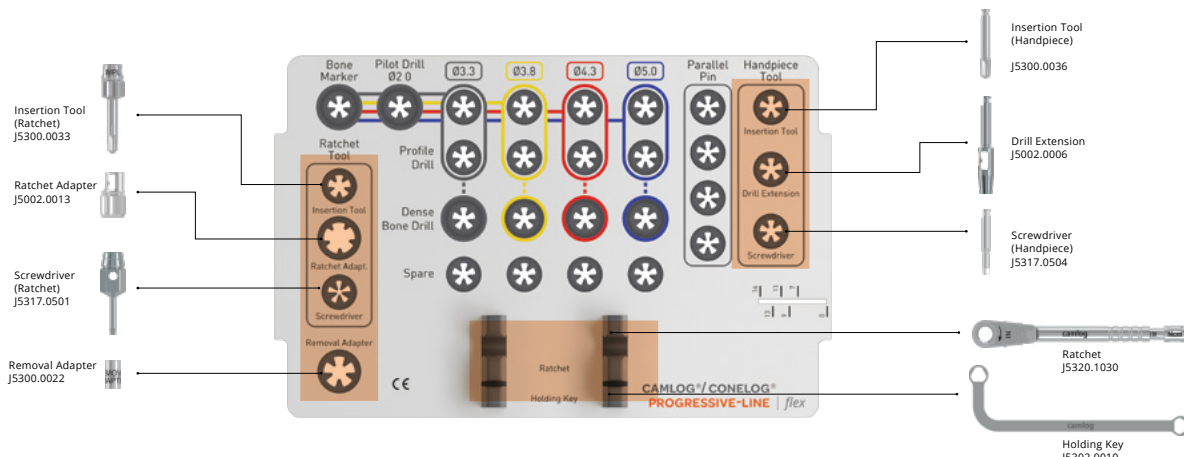

# Standard & soft bone drilling sequence

## Implant bed preparation

CONELOG® PROGRESSIVE drills are arranged and sorted in the set according to the treatment sequence. Color-coded lines on the surgical kit indicate the exact drilling sequence. Overview of the implant bed preparation using the example of a CONELOG® PROGRESSIVE Promote® Plus implant, length 13 mm.

The standard drilling sequence for the CONELOG® PROGRESSIVE implant, according to Flex protocol, includes the following steps:

- Punch/mark the desired implant position, for example with the Ø 2.3 mm round bur
- Drill to depth along the implant axial line with the Ø 2.0 mm pilot drill
- Check the drilling depth and drilling axis with the Ø 2.0 mm parallel pin
- Finalize the osteotomy depth with the final drill and shape cavity with the profile drill
- **Profile drills are required for all drilling sequences** (*soft, standard and dense*)
- Probe the implant osteotomy to check for intact bony walls and the correct depth

### IMPORTANT NOTE

If too high torques are achieved during insertion of the implants, it is necessary to revert to the standard protocol.

### CAUTION

The maximum apical overlength of the drills is 0.5 mm.

### IMPORTANT NOTE

A tap (max. 15 rpm) can be used as an alternative to the dense bone drill. The use of both the dense bone drill as well as the tap in the preparation of the implant bed can lead to a reduction in primary stability. This can be a desired characteristic particularly in hard bone.

## Ø 3.3 mm

### Standard Drill Sequence

For bone quality 1 and 2<sup>6</sup>, the use of a dense bone drill is required to reduce the insertion torque. In very dense bone the tap can be used to further minimize the insertion torque. See page 20 for further instructions on these instruments.

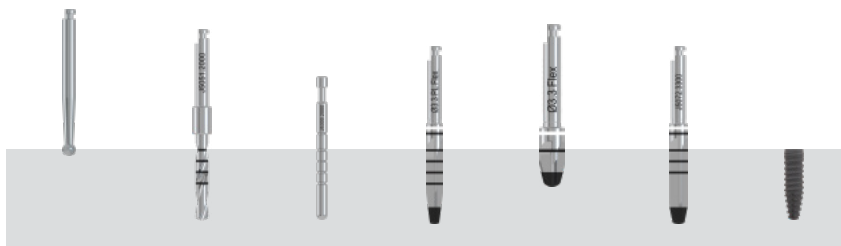

Ø 2.3 mm  
Bone  
Marker

Ø 2.0 mm  
Pilot Drill

Parallel  
Pin

Ø 3.3 mm  
Drill

Ø 3.3 mm  
Profile Drill

Ø 3.3 mm  
Dense Bone  
Drill  
**(mandatory in  
dense bone)**

Ø 3.3 mm  
CONELOG®  
PROGRESSIVE

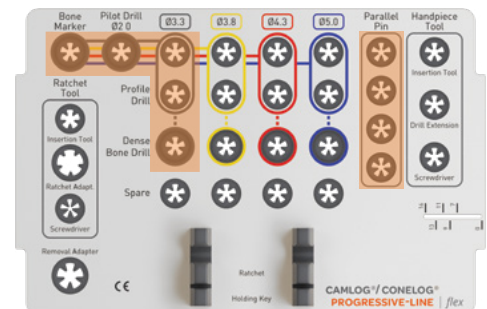

## Ø 3.8 mm

### Standard Drill Sequence

For bone quality 1 and 2<sup>6</sup>, the use of a dense bone drill is required to reduce the insertion torque. In very dense bone the tap can be used to further minimize the insertion torque. See page 20 for further instructions on these instruments.

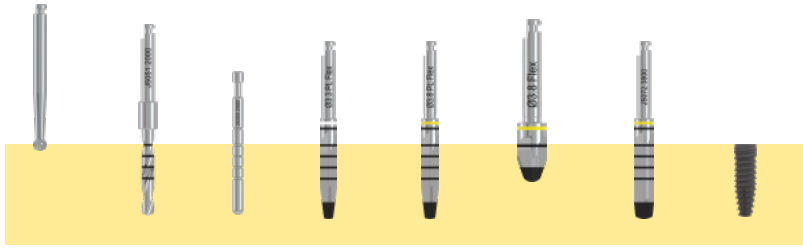

Ø 2.3 mm Bone Marker  
 Ø 2.0 mm Pilot Drill  
 Parallel Pin  
 Ø 3.3 mm Drill  
 Ø 3.8 mm Drill  
 Ø 3.8 mm Profile Drill  
 Ø 3.8 mm Dense Bone Drill  
 Ø 3.8 mm CONELOG<sup>®</sup> PROGRESSIVE  
 (mandatory in dense bone)

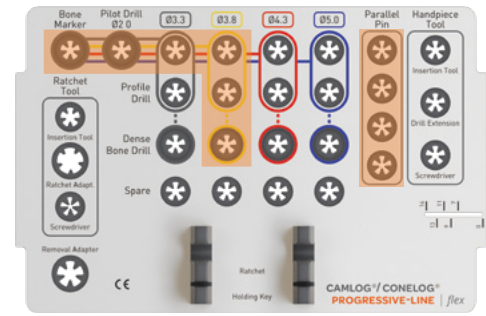

## Ø 3.8 mm

### Soft Bone Drill Sequence

In particularly soft bone, it is sometimes advisable to underprepare the implant bed to achieve additional primary stability. **Underpreparation** is achieved by not using the final drill intended according to the standard drill sequence.

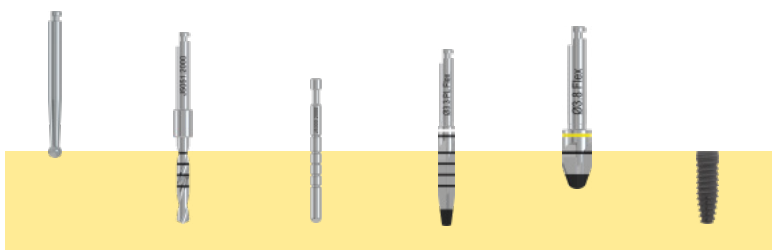

Ø 2.3 mm Bone Marker  
 Ø 2.0 mm Pilot Drill  
 Parallel Pin  
 Ø 3.3 mm Drill  
 Ø 3.8 mm Profile Drill  
 Ø 3.8 mm CONELOG<sup>®</sup> PROGRESSIVE

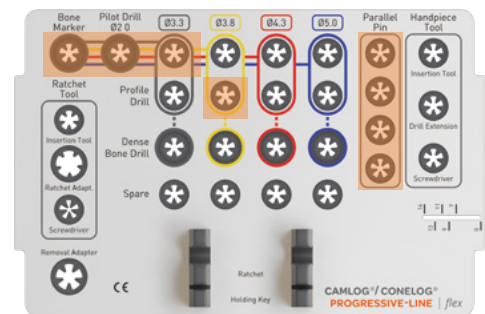

#### IMPORTANT NOTE

If too high torques are achieved during insertion of the implants, it is necessary to revert to the standard protocol

## Ø 4.3 mm

### Standard Drill Sequence

For bone quality 1 and 2<sup>6</sup>, the use of a dense bone drill is required to reduce the insertion torque. In very dense bone the tap can be used to further minimize the insertion torque. See page 20 for further instructions on these instruments.

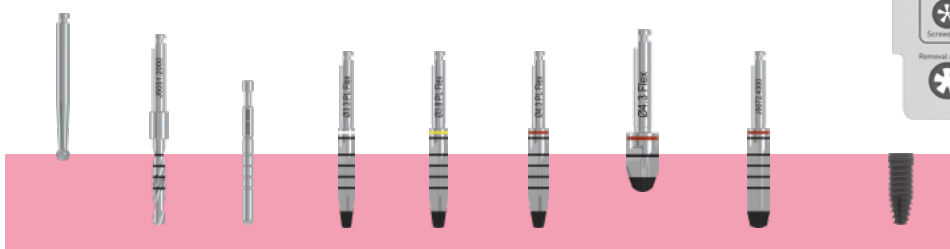

Ø 2.3 mm Bone Marker  
 Ø 2.0 mm Pilot Drill  
 Parallel Pin  
 Ø 3.3 mm Drill  
 Ø 3.8 mm Drill  
 Ø 4.3 mm Drill  
 Ø 4.3 mm Profile Drill  
 Ø 4.3 mm Dense Bone Drill  
 Ø 4.3 mm CONELOG<sup>®</sup> PROGRESSIVE  
 (mandatory in dense bone)

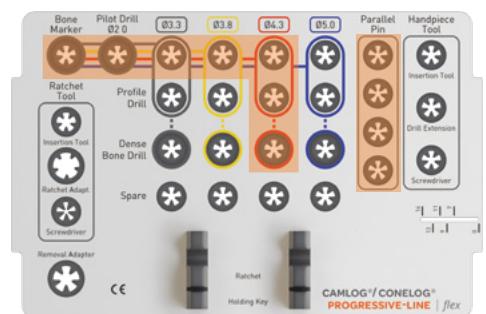



# Ø 4.3 mm

## Soft Bone Drill Sequence

In particularly soft bone, it is sometimes advisable to underprepare the implant bed to achieve additional primary stability. **Underpreparation** is achieved by not using the final drill intended according to the standard drill sequence.

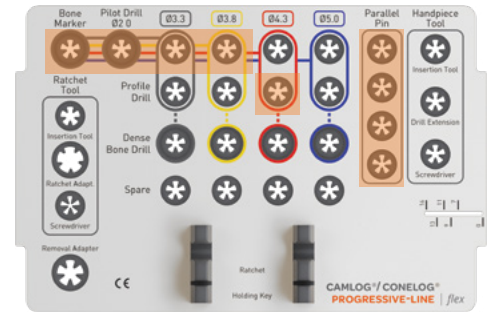
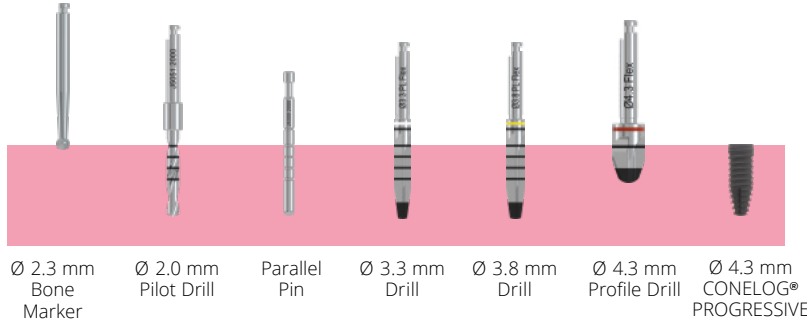

**IMPORTANT NOTE**  
If too high torques are achieved during insertion of the implants, it is necessary to revert to the standard protocol

# Ø 5.0 mm

## Standard Drill Sequence

For bone quality 1 and 2<sup>6</sup>, the use of a dense bone drill is required to reduce the insertion torque. In very dense bone the tap can be used to further minimize the insertion torque. See page 20 for further instructions on these instruments.

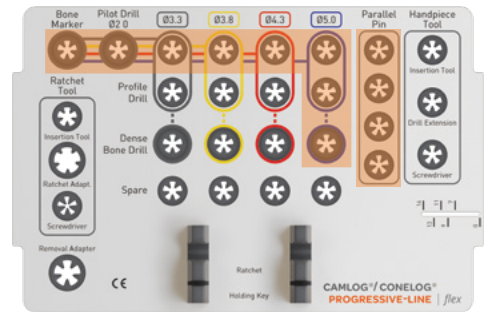
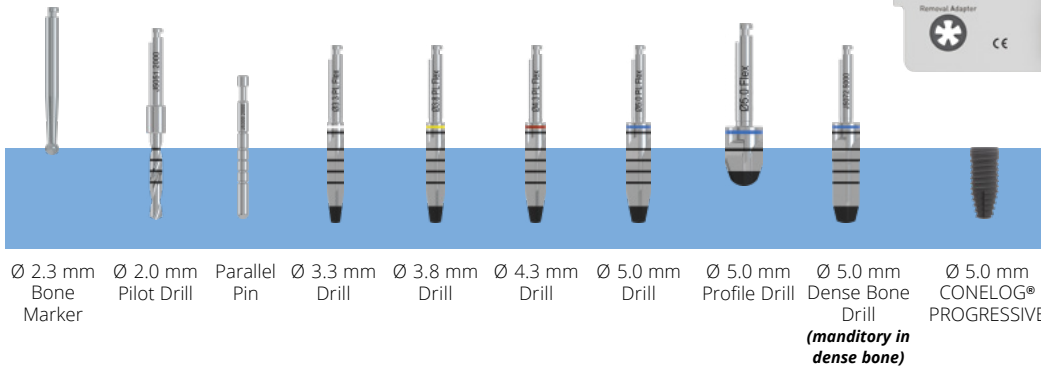

# Ø 5.0 mm

## Soft Bone Drill Sequence

In particularly soft bone, it is sometimes advisable to underprepare the implant bed to achieve additional primary stability. **Underpreparation** is achieved by not using the final drill intended according to the standard drill sequence.

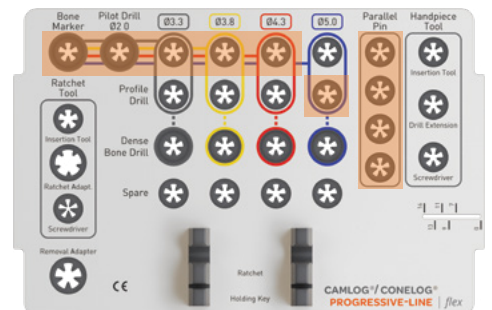
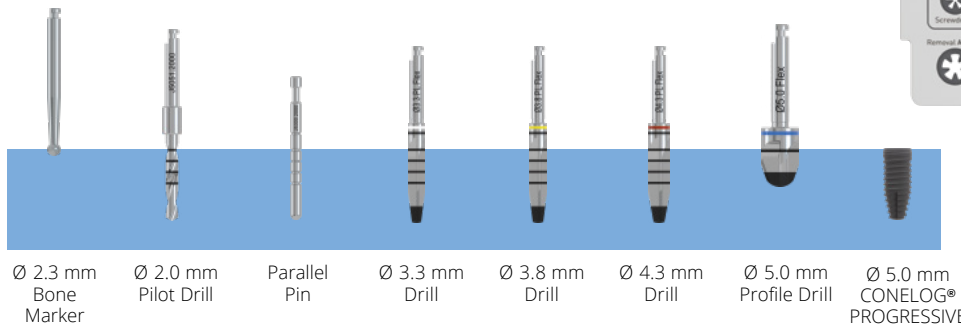

**IMPORTANT NOTE**  
If too high torques are achieved during insertion of the implants, it is necessary to revert to the standard protocol

# Packaging and implant handling

## General information

### A) Secondary packaging (cardboard box) with label:

The label on the secondary packaging contains relevant system information and is applied on three sides. This means that the label is clearly readable regardless of stacking of the packages.



Example product label on the secondary packaging for an implant with snap-in insertion post:

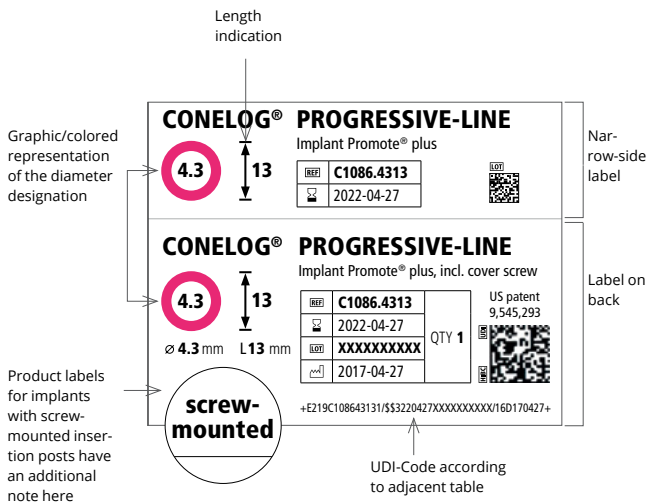

### UDI CODE

A B C DE F G H I J K  
 +E219 C10864313 / \$3 220427 XXXXXXXXXX /16D 170427 +

Sections of the primary code (UDI-DI)	Code	Explanation
A	+	Protected HIBC-ID (1 digit)
B	E219	Manufacturer's code (ALTATEC)
C	C10864313	Article number (max. 13 digits)
D	1	Quantity index (number of packaging units, 1 digit)
Sections of the secondary code (UDI-DI)	Code	Explanation
E	/	Separator primary/secondary
F	\$3	Identifier for expiry date
G	220427	Expiry date (6 digits) 27.04.2022
H	XXXXXXXXXX	Manufacturer's batch (10 digits)
I	/16D	Identifier for date of manufacture
J	170427	Date of manufacture (6 digits) 27.04.2017
K	+	Variable test mark

Further information on the secondary packaging:  
 The bottom side of the CONELOG® Implant packaging refers to the instructions for use in electronic form: <https://ifu.camlog.com>. In addition, it includes a QR code which links directly to the corresponding Internet page.

The left side view of the CONELOG® Implant packaging contains the CE label, the corresponding warnings as well as the address of the manufacturer.

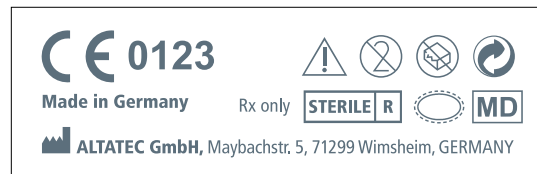

# Packaging and implant handling

## General information

### Explanation of symbols

	CE-label
	Consult instructions for use
	Caution, observe the warning notices
	Medical device
	Article number
	Lot number
	Sterilized using irradiation
	Single sterile barrier system with protective packaging outside
	Non-sterile
	Date of manufacture

	Use-by date
	Do not resterilize
	Do not reuse
	Do not use if package is damaged
	Keep away from sunlight
	Temperature limit
	Manufacturer
	MR-Conditional
	Caution: US Federal law restricts this device to sale by or on the order of a dentist or physician.

### Explanation of abbreviations

∅	Diameter
A∅	Apical diameter
G∅	Gingival diameter
PP∅	Prosthetic platform diameter
L	Length
GH	Gingival height
PEEK	Poly ether ether ketone
POM	Polyoxymethylene
PS	Platform Switching
PPSU	Polyphenylsulphone

### B) Transparent blister with Tyvek® foil and primary label:

The blister with the Tyvek® foil represents the primary packaging, the contents of which are sterile – implant holder with implant and cover screw. Furthermore, the secondary packaging includes four self-adhesive patient labels. These can, for example, be used for the patient records or the letter of referral. For faster identification, the diameter information is also highlighted in color here.

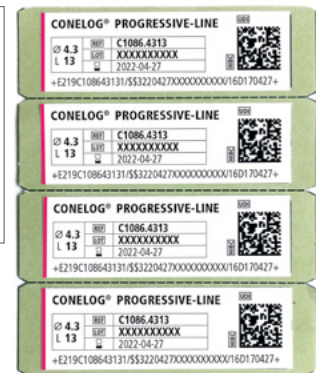
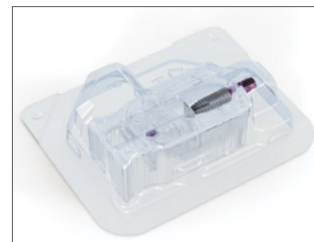

### C) Implant holder with implant and cover screw:

The implant holder securely fixes the implant and the cover screw in the packaging. Both the implant and the cover screw can be released and removed via a simple click mechanism with the implant holder. In addition, the implant can also be clearly identified in the implant holder after removal from the primary packaging:

- The implant diameter can be identified via the color-coding of the insertion post and the cover screw.
- For implants with a snap-in insertion post, a scale on the bottom side of the implant holder indicates the length of the implant: the position of the titanium retaining plate on the scale indicates the implant length 7, 9, 11, 13 and 16 mm.

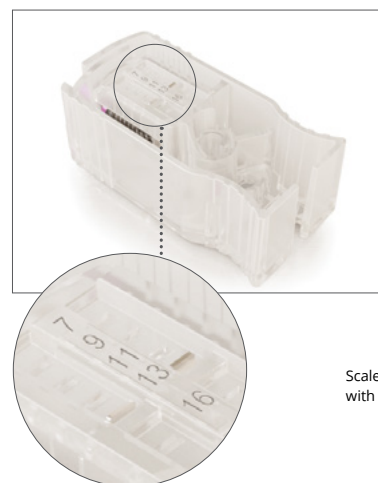

Scale to determine the length of implants with a snap-in insertion post

# Insertion tools

## General information

### D) Snap-in insertion posts:

The implants are secured in the implant holder with a color-coded insertion post corresponding to the diameter. The insertion posts are snapped in the implant and can be removed easily from the implant after implantation without requiring further tools.



### E) Screw-mounted insertion posts:

In addition to the version with the snap-in insertion post, there is also a variant where the insertion posts are firmly screw-mounted in the implant. This is specifically indicated on the label of the secondary packaging (see page 14). The screw-mounted variant is necessary for guided surgery (Guide) to be able to place the implant via the surgical guide. However, it can also be used whenever a correction of the intraoperative position of the implant in all three spatial dimensions may prove necessary during insertion.

Both the snap-in insertion posts and the screw-mounted insertion posts are color-coded and secured with the implant in the implant holder. After implantation, the screw-mounted connection of the insertion post to the implant must first be disengaged. Only then can the insertion post be removed from the implant.



### F) Insertion tools:

The implant can be picked up directly with the insertion tool (snap-in or screw-mounted) via the insertion post and removed from the implant holder. One of the five illustrated insertion tools can be used for this purpose.

Furthermore, the long insertion tools also allow the placement of implants in narrow and deep anatomical situations.

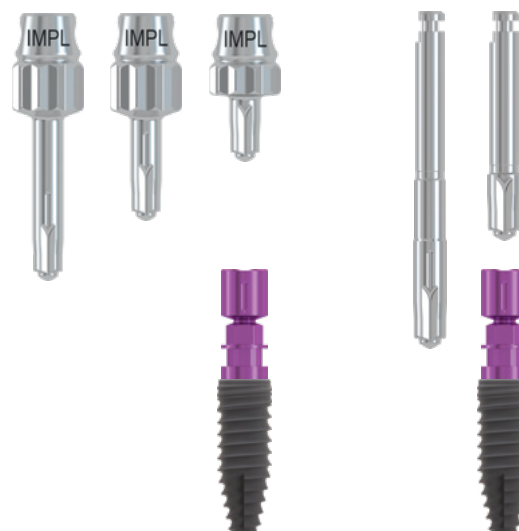

The three manual insertion tools for use with the wrench (long, short, extra short).

The two insertion tools with ISO shaft (long and short) for use with the angled hand piece.

# Insertion tools

## General information

The figure on the right side illustrates the use of a handpiece insertion tool (with ISO shaft) with insertion post for the Ø 3.3 mm implant under tight interdental conditions.

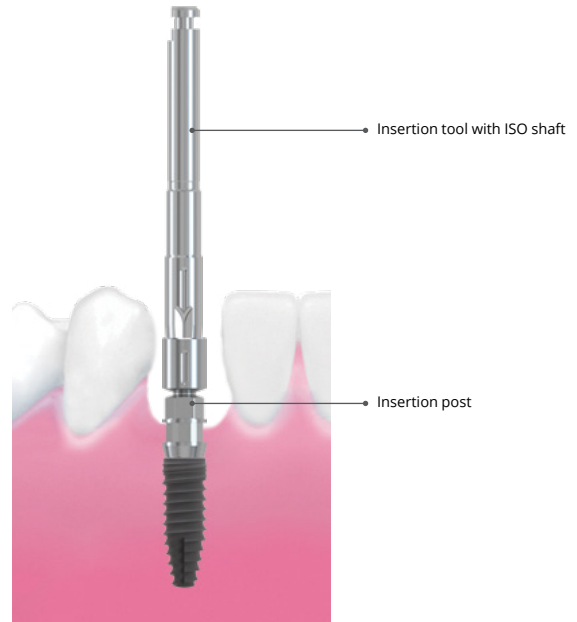

**NOTE**  
The insertion tools and in particular the snap-in insertion posts are designed such, that they are also suitable for narrow gaps. All of these components are narrower than the implant itself.

### G) Insertion aid:

If a low primary stability is expected during sinus lift surgery, BioHorizons Camlog recommends the use of implants with screw-mounted insertion posts. These allow intraoperative position correction of the implant in all three spatial dimensions if required. If the use of an implant with a snap-in insertion post was planned, BioHorizons Camlog recommends mounting the insertion aid (see page 27) instead of the pre-assembled, snap-in insertion post. The insertion aid is screw-retained unlike the snap-in insertion post, and also allows intraoperative corrections in positioning of the implant in all three spatial dimensions.



### Drill speeds

Depending on the drill type and diameter, the maximum drill speeds (350-800 rpm) vary according to the table. (handpiece angle reduction ratio 16:1–20:1).

The maximum speed for taps is 15 rpm (contra-angle reduction 70:1-100:1). The tap adapter for the torque wrench also permits manual tapping.

### Cooling of drills

Cooling is performed through external irrigation on the angled hand piece with sterile saline solution (pre-chilled to 5 °C / 41 °F).

### Drill life

Drill longevity depends on bone quality and the drilling technique. Drills are suitable for 10–20 drilling cycles. If excessive force has to be applied because of a dull drill, change the drill immediately to prevent overheating of the bone.

**CAUTION**  
The maximum apical overlength of the drills is 0.5 mm.

Description	Ø	max. speed (rpm)
Round bur	-	800
Pilot drill	2.0 mm	800
Drills	3.3 mm	550
	3.8 mm	500
	4.3 mm	400
	5.0 mm	350
Profile drills	3.3 mm	550
	3.8 mm	500
	4.3 mm	400
	5.0 mm	350
Dense bone drills	3.3 mm	550
	3.8 mm	500
	4.3 mm	400
Taps	5.0 mm	350
	4.3 mm	400
	3.8 mm	500
	3.3 mm	550
Taps	3.3 mm	15
Taps	3.8 mm	15
Taps	4.3 mm	15
Taps	5.0 mm	15

# Surgical Procedure

## Drilling sequence



**01. Incision line**

The procedure used as an example illustrates the insertion of a  $\varnothing 4.3/L 13$  mm CONELOG® PROGRESSIVE Promote® Plus implant. The incision and flap formation result from the planned implant position and the clinical characteristics of the implantation site.

There is also the option of using a tissue punch (gingiva punch) to gain access to the bone. Corresponding gingiva punches (Guide System gingiva punches) are available.



**02. Punch-marking the cortical bone**

The  $\varnothing 2.3$  round bur is used for punch-marking the cortical bone, which simplifies the use of the drills to follow. The round bur only needs to be driven to partial depth to mark the cortical bone.

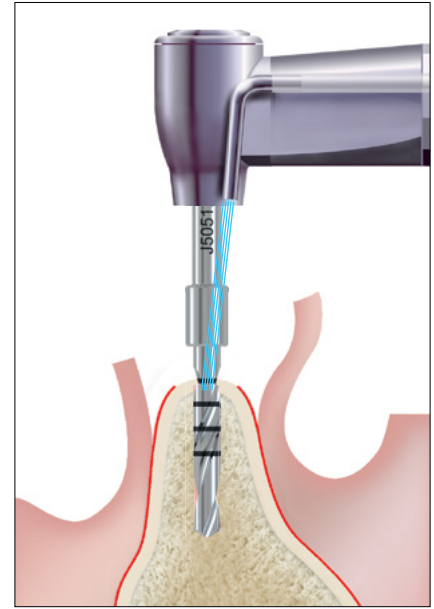

**03. Pilot drilling**

The pilot drill determines the depth and axis of the implant site. The depth marks on the drill correspond to the implant lengths 7, 9, 11 and 13 mm. The maximum drilling depth is 16 mm.





# Surgical Procedure

## Drilling sequence

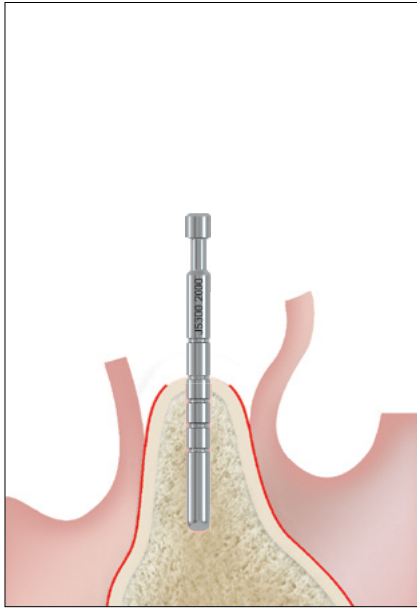

04. Parallel pin

Once drilling is complete, the depth and axis of the implant bed is checked using the parallel pins with depth marks. If several implants are being placed, a parallel pin is inserted into the first hole in order to align the other implant axes.

The pilot drill is aligned parallel to the parallel pin and visually checked from two planes (sagittal and transversal).

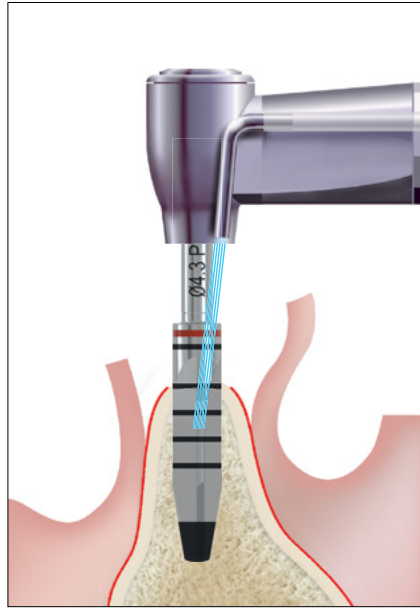

05. Prepare the cavity

The diameter of the implant bed is gradually increased with the series of drills until the intended final diameter is achieved. The small increases in diameter allow for a gentle preparation of the bone.

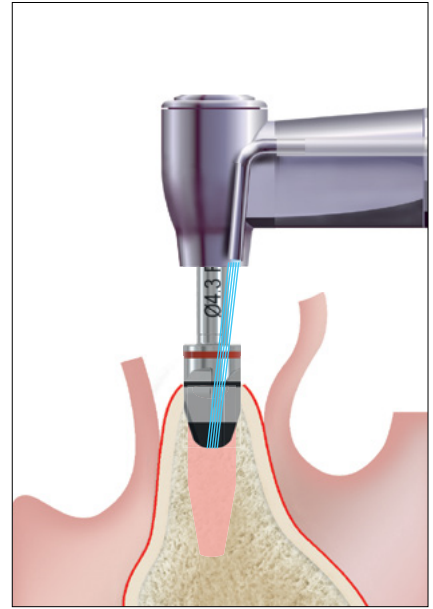

06. Define the final form of the cavity

After finalizing the diameter of the osteotomy, the profile drill needs to be used to form the crestal part of the osteotomy.

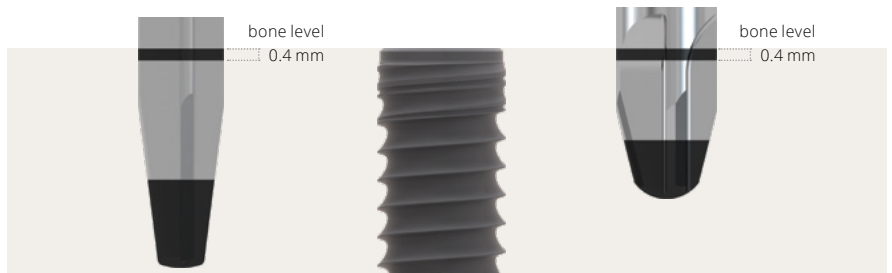

Parallel pins are used to check the depth and axis of the implant bed and for radiographic evaluation of proximity to adjacent anatomy

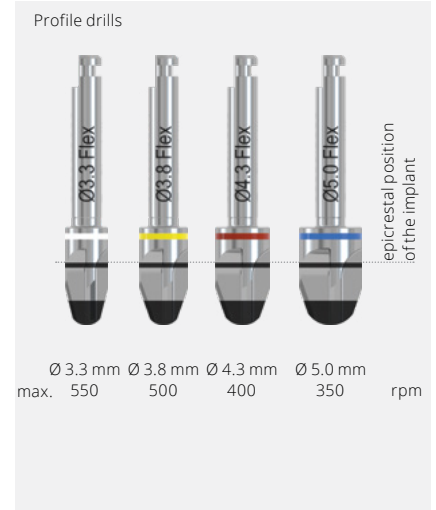
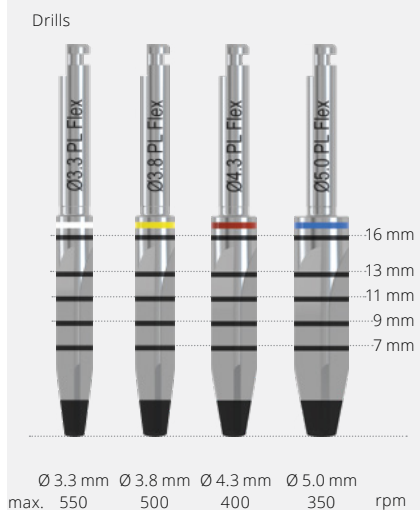
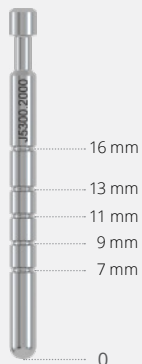

# Surgical Procedure

## In dense bone

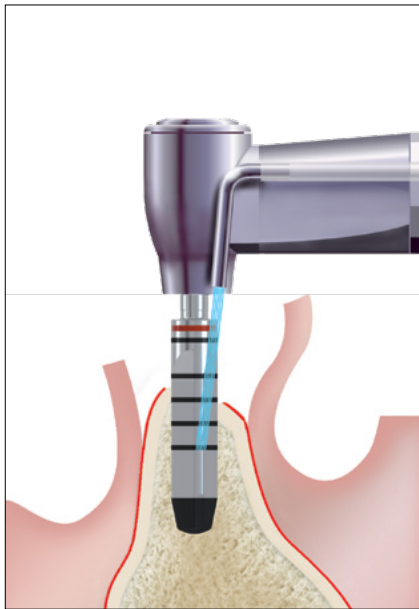

07. Dense bone drill

All CONELOG® PROGRESSIVE implants come with a self-tapping thread. However, for bone qualities 1 and 2<sup>5</sup>, the use of the dense bone drills is required to reduce the torque when inserting the implant. The use of the dense bone drill is considerably easier compared to the tap, as the dense bone drill can be used at higher speeds and without changing the direction of rotation like all drills. It can be used directly using the angled hand piece. Furthermore, the four cutting edges of the dense bone drill allow the collection of bone chips.

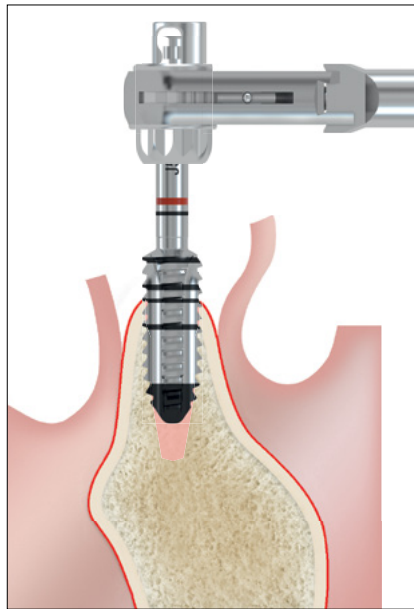

08. Alternative: Tap

Taps can be used as an alternative to the dense bone drill. These are inserted into the osteotomy at different depths depending on the implant length. The marks on the taps represent the length-specific insertion depths (not proportional to the implant length) for 7 mm, 9 mm, 11 mm, 13 mm and 16 mm implants. The maximum speed of 15 rpm must not be exceeded with automated tapping. Manual tapping is recommended.



09. Torque wrench use with tap

The adapter ISO shaft and the locked torque wrench are used to manually tap the thread. Make sure to pay attention to the axial direction of the implant bed when inserting and removing the tap.

### Implant insertion:

When using the tap it might be helpful to initially turn the implant counter-clockwise until it settles into the pre-tapped threads.

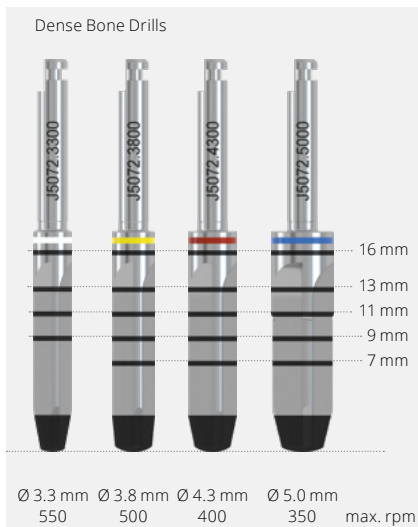

# Opening of the package

## Transfer of the implant holder to the sterile zone



### 01. Opening the packaging

The secondary packaging is opened with the perforated packaging tab.



### 02. Patient labels

The four self-adhesive patient labels included with the blister, are intended for documentation purposes for example:

- Patient records
- Letter of referral



### 03. Opening of the blister

At the two sharp angle corners, the blister is fitted with tabs which allow easy separation of the Tyvek® foil from the blister.

The blister with the Tyvek® foil forms the sterile barrier. As long as the blister as well as the Tyvek® foil are undamaged, sterility of the content is assured.

#### NOTE

If the perforated packaging tab is partially or fully open, the packaging is deemed damaged and the implant may no longer be used.

# Opening of the package

## Transfer of the implant holder to the sterile zone

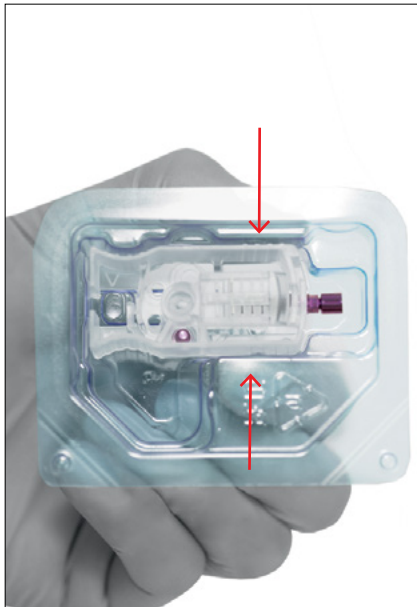

### 04. Transfer to the sterile zone

There are two ways to transfer the implant holder to the sterile zone (A and B):



### 5A. Press fingers

Discarding the implant holder onto the sterile shelf. The opened blister is gently compressed between two fingers in the marked position.



### 6A. Release onto sterile shelf

By releasing finger pressure, the holder can be discarded onto the sterile shelf in a controlled manner.



### 5B. Passing the blister

The opened blister is passed to the implantologist.



### 6B. Taking of the implant holder

The implantologist takes the implant holder with two fingers to the intended place. The implant holder can be used in the sterile zone.

# Picking up the implant

With the manual insertion tool

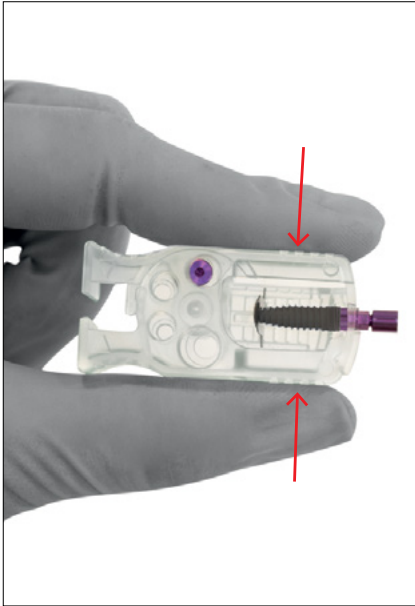

## 01. Implant holder fixation

The front part of the implant holder is held between two fingers and the insertion tool is mounted into the insertion post.

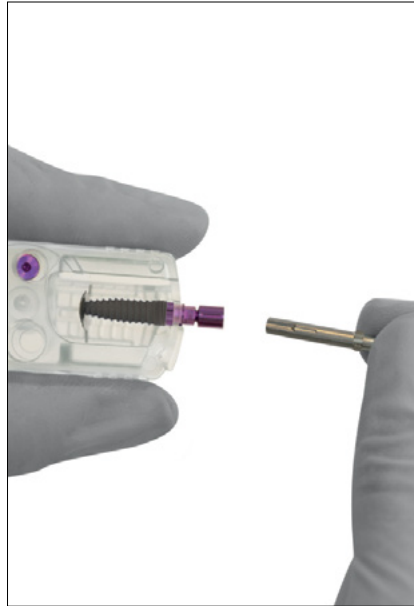

## 02. Apply pressure

It should be noted that picking up the insertion post with the insertion tool is done by applying pressure. This ensures a secure hold of the insertion tool in the insertion post.

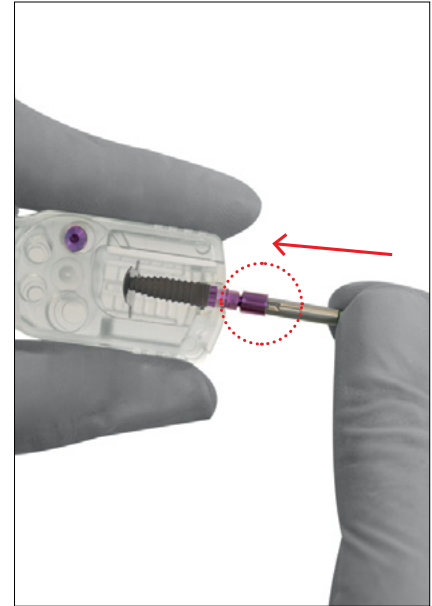

## 03. Correct alignment

Observe the correct alignment of insertion post with the insertion tool during the pick-up process. Furthermore, the three groove markings on the insertion tool and on the insertion post relate to the groove position of the implant-abutment connection.

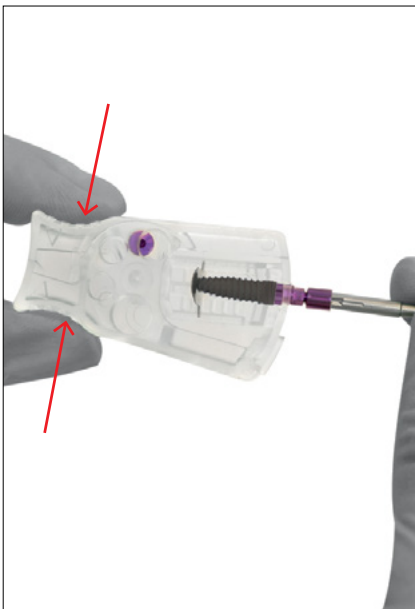

## 04. Release implant lock

Only after inserting the insertion tool on the insertion post, press the implant holder together at the rear section (see arrows in the illustration) to release the lock on the implant holder and thus the implant.

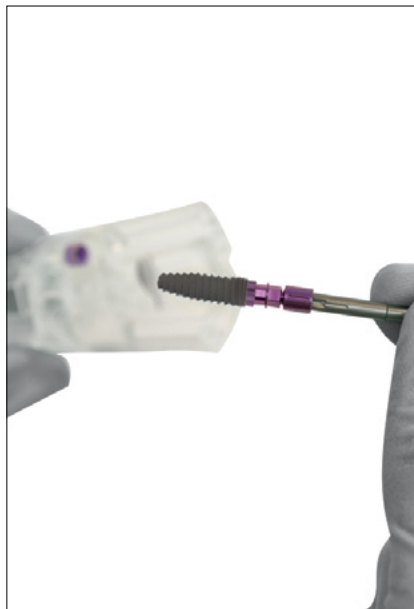

## 05. Lift implant

Lift out the implant on the insertion post upwards in a straight line (do not bend).

# Picking up the implant

With the angled hand piece

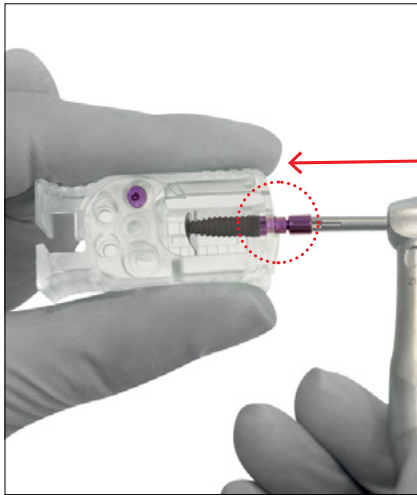

## 01. Implant holder fixation

To pick up the implant holder directly with the machine insertion tool (with ISO shaft) and angled hand piece: the front part of the implant holder is fixed with two fingers. Then the insertion post is picked up with the machine insertion tool or angled hand piece. It should be noted that picking up the insertion post with the insertion tool is done by applying pressure. This ensures a secure hold of the insertion tool in the insertion post.

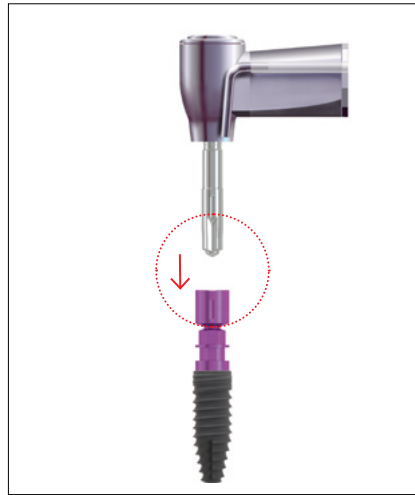

## 02. Correct alignment

During the pick-up process, observe the correct alignment of the three groove markings on the head of the insertion post and the insertion tool.

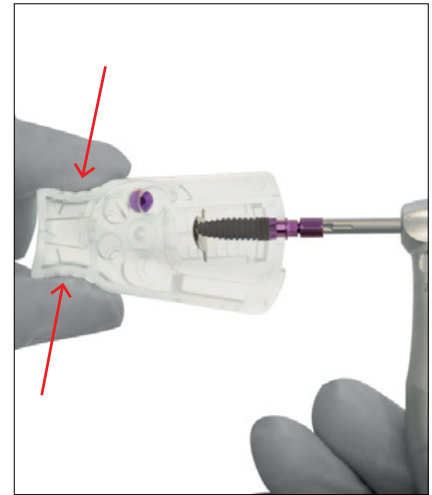

## 03. Release implant lock

Only after inserting the insertion tool on the insertion post, press the implant holder together at the rear section (see arrows in the illustration) to release the lock on the implant holder and thus the implant. Lift out the insertion post upwards in a straight line (do not bend).

# Pick-up instrument

For implants with snap-in insertion post

By default, the implant can be removed from the implant holder with the insertion tool. As an alternative to the insertion tool, the Pick-up instrument can also be used to remove the implant.

The Pick-up instrument is pushed into the notch on the snap-in insertion post above the hexagon.

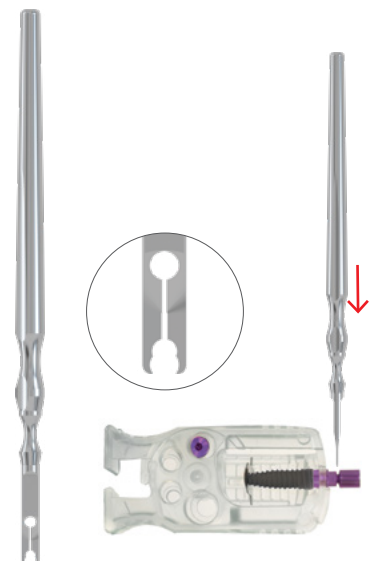

Pick-up instrument



# Implant insertion and positioning

## With the manual insertion tool

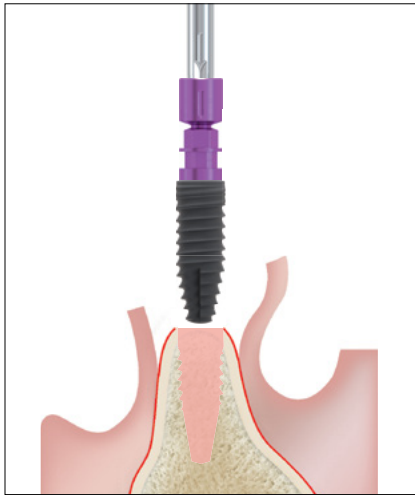

**1A. Insertion by hand**

The implant is inserted manually into the coronal section of the implant bed using the insertion tool.

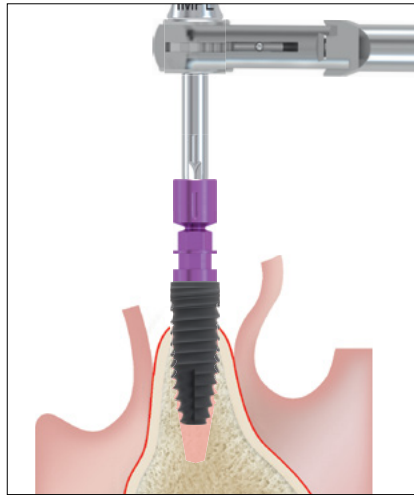

**2A. Manual insertion**

Further insertion of implant with manual insertion tool and wrench, clockwise.\*

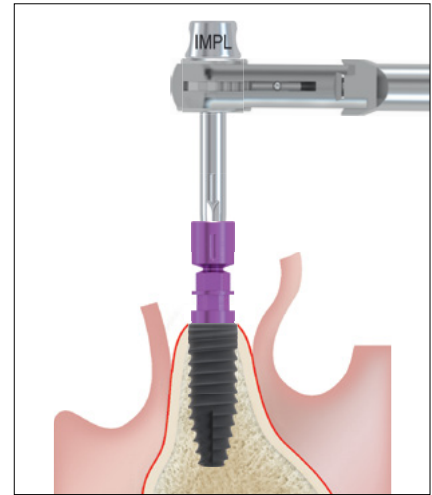

**3A. Orientation of grooves**

When reaching the planned insertion depth, one of the three grooves should face in a vestibular direction.

**\* NOTE**

Pay attention to the axial alignment of the implant bed. If the thread was tapped in advance, the positions of the threaded ends in the cortical bone and on the implant must match. It is recommended to first rotate the insertion tool with the implant carefully to the left manually, until the thread socket can be felt. Then the implant is screwed in clockwise manually with the insertion tool.

**NOTE**

Each groove is 120° apart, advancing from one groove to the next will result in the implant progressing 0.3 mm deeper.

## Retrieving the insertion post



**4A. Orientation of grooves**

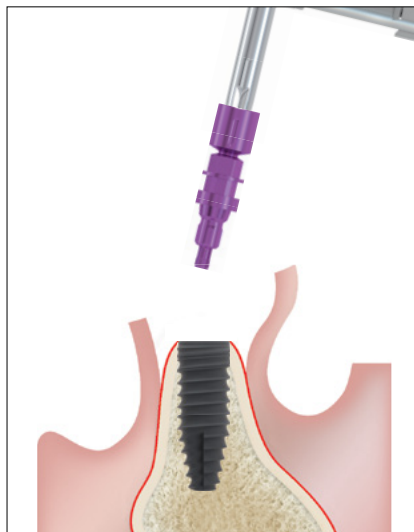

**5A. Retrieve insertion post (snap-in)**

**Snap-in insertion posts:**

The snap-in insertion post can be pulled directly from the implant with the insertion tool. Sufficient primary stability of the implant should be available here. Should the insertion post inadvertently remain in the implant, it can simply be pulled out with forceps. If it is desired to leave the insertion post in the implant for the time being (e.g. in order to be able to compare the axes of several implants better), the insertion post may have to be retained in the implant by applying axial pressure using a suitable instrument in order to loosen the insertion tool from the insertion post.

If the primary stability is not sufficient, the implant can be stabilized with a suitable instrument during extraction of the insertion post.

# Implant insertion and positioning

With the angled hand piece

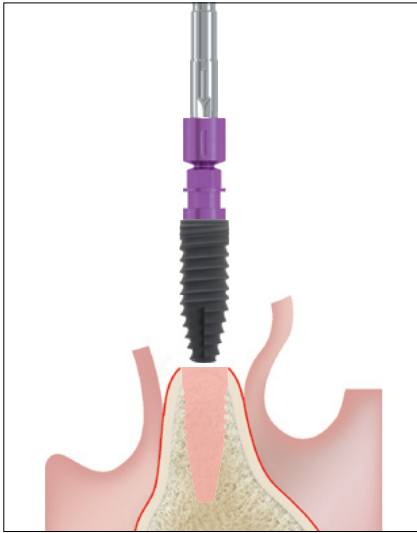

## 1B. Placing the implant

Insert the implant into the coronal section of the implant bed.

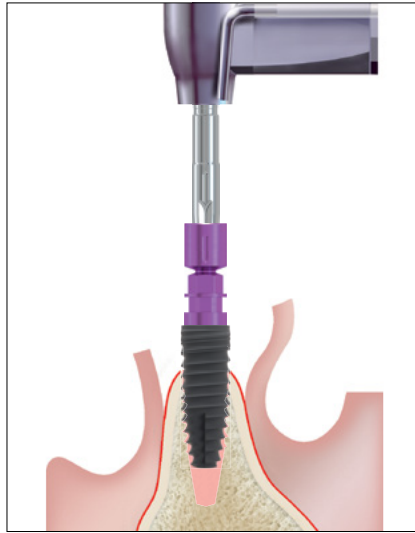

## 2B. Insertion with hand piece

Further insertion of implant clockwise with angled hand piece (max. 15 rpm).

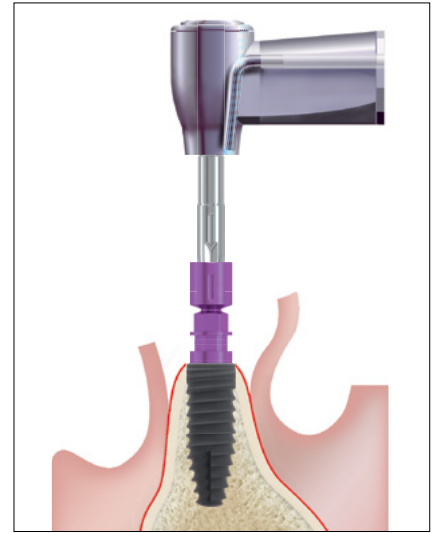

## 3B. Orientation of grooves

When reaching the planned insertion depth (see page 19), one of the three grooves should face in a vestibular direction.

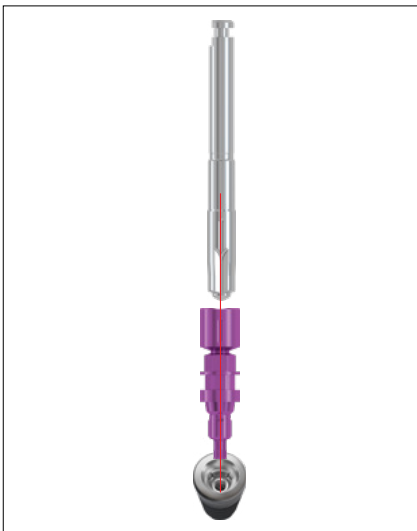

## 4B. Orientation of grooves

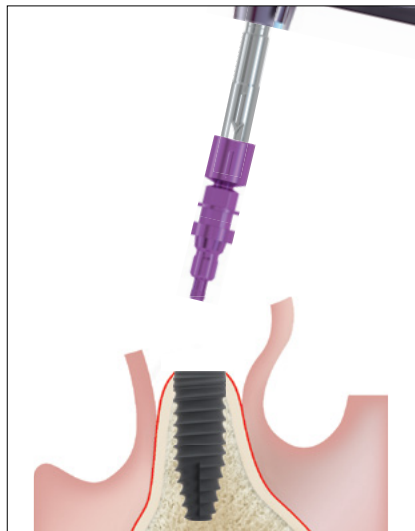

## 5B. Retrieve insertion post (snap-in)

Removal of the snap-in insertion post for machine screwing in

## Screw-mounted insertion posts

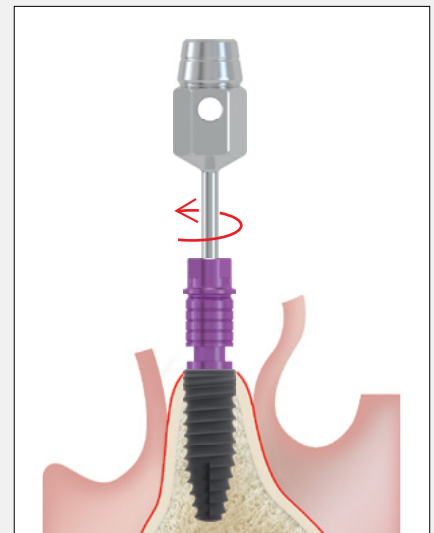

## Remove the insertion posts

After removing the insertion tool, loosen the screw inside the insertion post with the screwdriver, hex, and remove the insertion post with the forceps or by hand (danger of aspiration!). In the case of low primary stability, BioHorizons Camlog recommends using the universal holding key to counter the implant when loosening the screw to prevent movement of the implant.

# Additional instruments

## Insertion aid

In situations in which an implant with a snap-in post has been chosen but only low primary stability is reached, the short insertion aid can be applied. The insertion aid is screw retained unlike the snap-in post, and allows intraoperative corrections in positioning of the implant in all three spatial dimensions.

The insertion aid can be mounted as described below:



**01**

Pick up implant with the insertion tool.

Slide the color-coded sleeve with the appropriate diameter over the endosseous part of the implant.

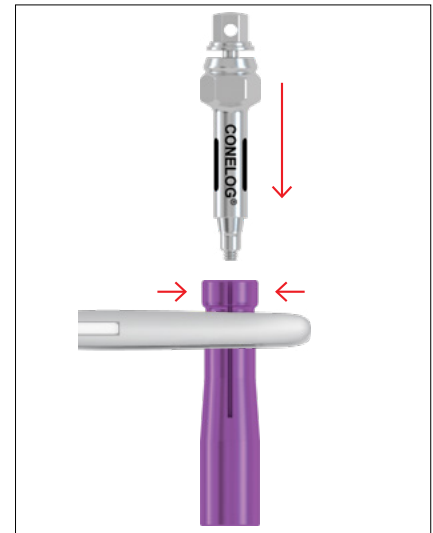

**02**

Compress sleeve at implant shoulder level with a hemostatic clip.

Implant with snap-in insertion post: remove insertion tool with insertion post  
 Implant with screw-mounted insertion post: unscrew insertion post.  
 Insert the insertion aid appropriate for the diameter into the implant until the cams engage in the grooves.

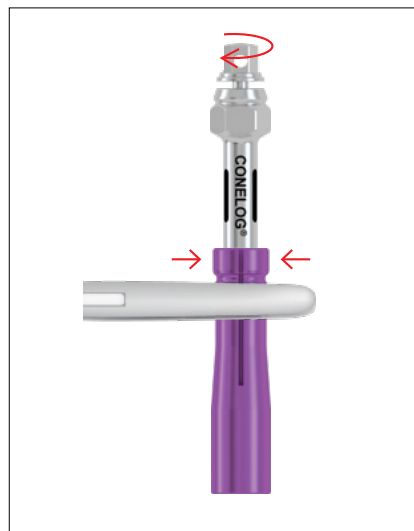

**03**

Fixation of the implant with the fixing screw of the insertion aid (tighten manually).

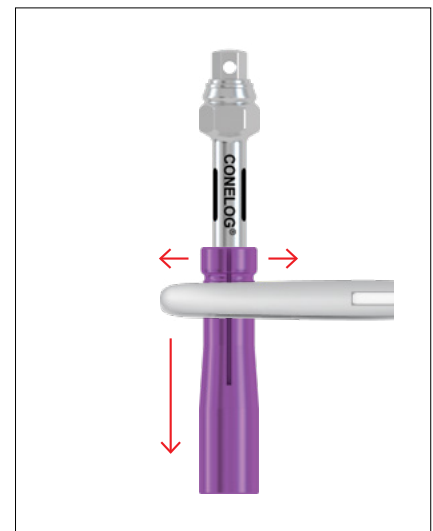

**04**

Remove the hemostatic clip and the sleeve

**IMPORTANT NOTE**

The hemostatic clip, the Insertion aid and the sleeve must be sterilized prior to use.

# Additional instruments

## Pick-up instrument

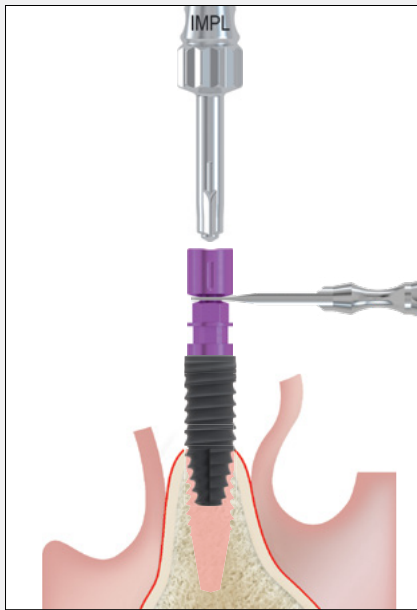

Mounting the insertion tool

# Surgical procedure

## Removal adapter

### Removal adapter for implants / pre-defined breaking point of the snap-in insertion posts

If the torque or bending moment are too high when screwing in the implant, the snap-in insertion post snaps off at the pre-defined breaking point. This protects the implant. The design ensures that the implant is not damaged and that the fracture fragment of the post can be removed with forceps as a single piece from the implant.

If the pre-defined breaking point snaps, the fractured piece must be secured with a thread prior to removal to avoid aspiration.

The following two situations may occur:

**A:** If snapping at the pre-defined breaking point occurs at the same time as final positioning of the implant, the fragment of the snap-in insertion post is extracted as described above, and the restoration can be continued as planned. The cover screw or a healing cap is inserted into the implant,

or it can be fitted with a prosthetic component.

**B:** If the implant is not in the final position when the predefined breaking point snaps, the implant must be removed as described below, and the reason for snapping should be investigated.

The removal adapter is used to unscrew the implant after the predefined breaking point of the snap-in insertion post has snapped. To do this, remove the fragment and place the removal adapter on the broken snap-in insertion post in the implant. Insert the insertion tool into the removal adapter and unscrew the implant counter-clockwise using the initially blocked torque wrench.

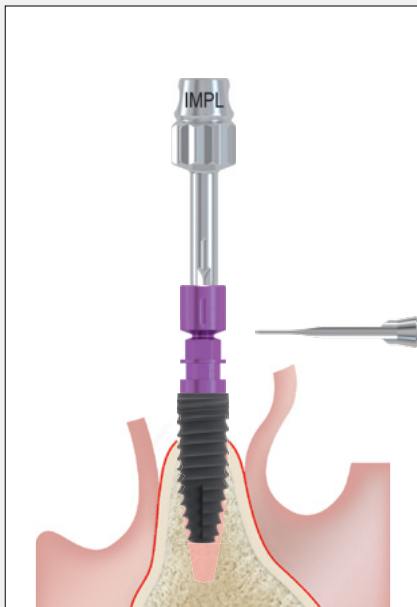

Removing the Pick-up instrument and inserting the implant.



01

Placing the removal adapter on the broken insertion post

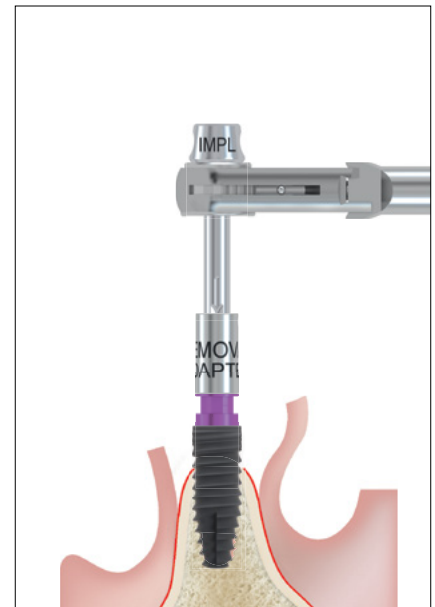

02

Unscrewing the implant with the aid of the removal adapter and mounted torque wrench

# Healing options overview

## Submerged healing and transgingival healing

### Tissue generation/tissue support

Application  
one-step use (transgingival)

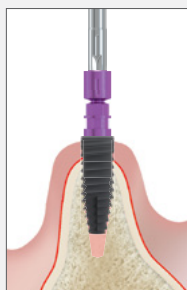

Application  
two-step use (submerged)

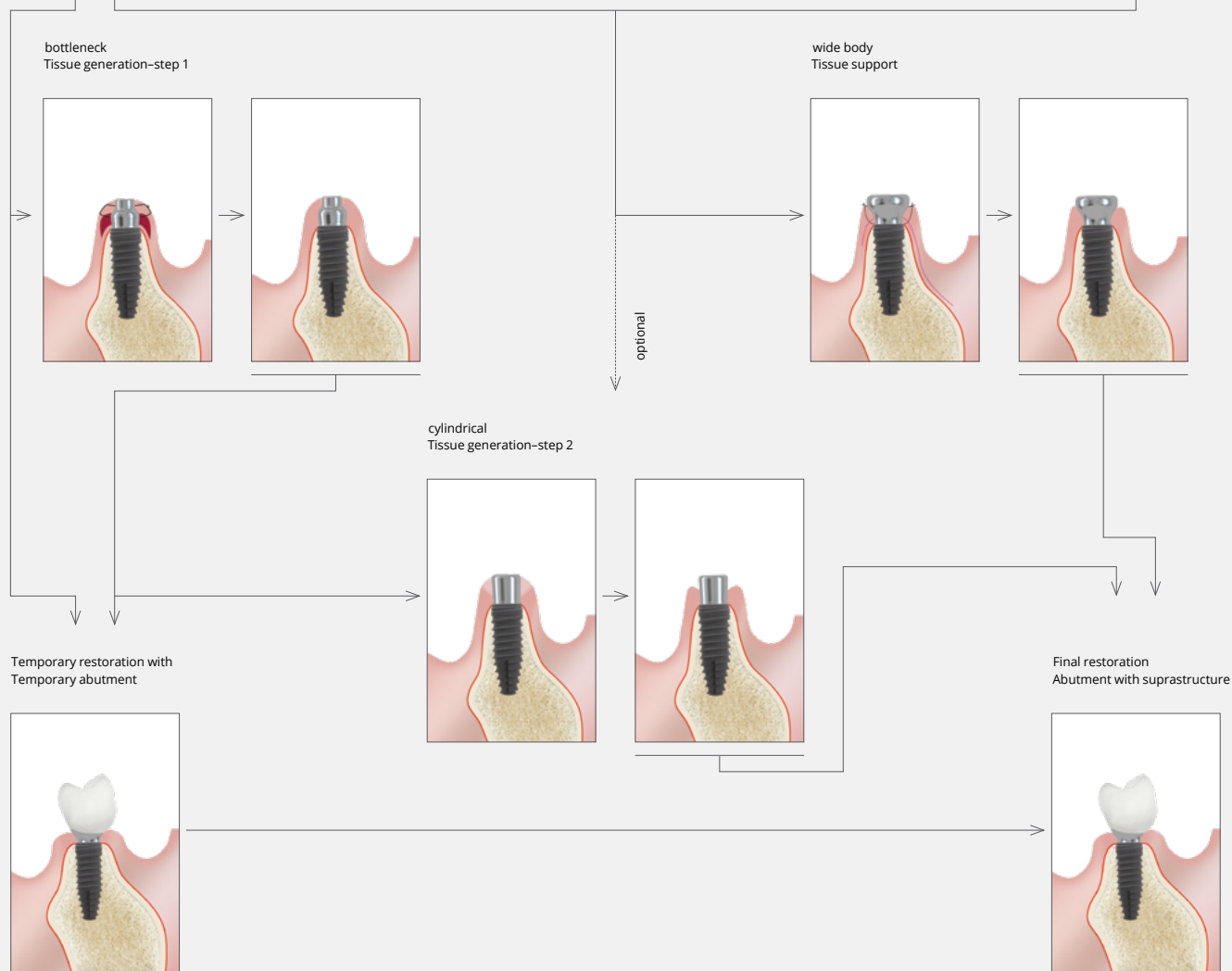
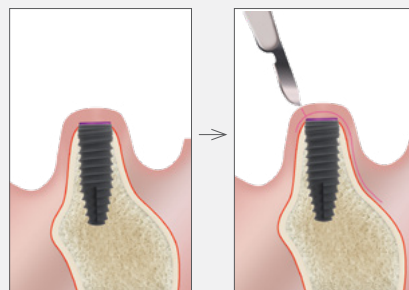

# Healing options

## Submerged healing



**01. Location of cover screw**

The cover screw for submerged healing is located in the middle section of the implant holder and protected against falling out in a provided well (Ø 3.3 mm, Ø 3.8 mm, Ø 4.3 mm and Ø 5.0 mm).

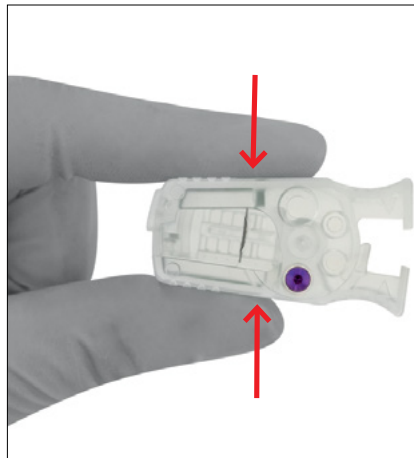

**02. Release of cover screw**

By closing (compressing) the implant holder (see illustrations) the cover screw can be released.

The screw is freely accessible after this procedure. This procedure is only possible if the insertion post and the implant are no longer in place.

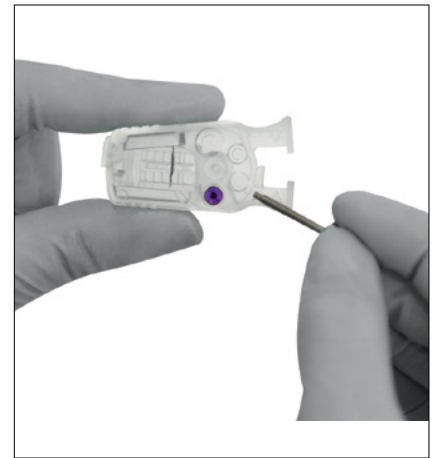

**03. Pick up of cover screw**

Using a screwdriver (hex driver), the cover screw can be picked up directly from the implant holder applying pressure.

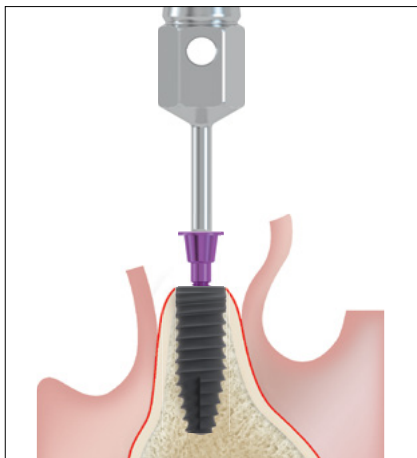

**04. Manual tightening**

Pick up the cover screw with the screwdriver, hex, and insert it into the CONELOG® PROGRESSIVE implant manually (danger of aspiration!). The cover screw must only be tightened manually using the screwdriver.

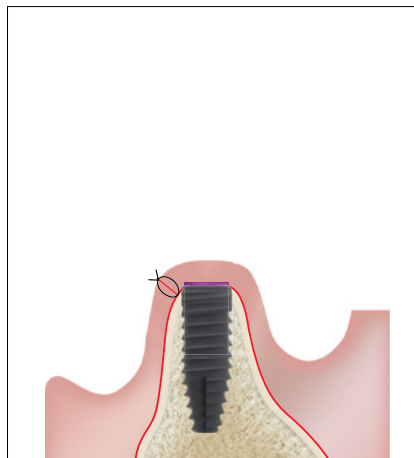

**05. Wound closure**

In a two-stage surgery, the implant is placed below the soft tissue and protected from occlusal function and other forces during osseointegration. A low-profile cover cap is placed on the implant to protect it from the ingress of soft tissue.

Following osseointegration, a second procedure exposes the implant and a transmucosal healing abutment is placed to allow for soft tissue healing and development of a sulcus. Prosthetic restoration begins after soft tissue healing.



# Healing options

## Transgingival healing (single-stage protocol)

### Healing cap, cylindrical and wide body

The cylindrical and wide body healing caps are for standard use. For insertion into the implant, a healing cap corresponding to the diameter, is screwed in manually using the screwdriver (hex driver). The gingival height is selected to ensure the healing cap lies supragingival by 1-1.5 mm. The impression is taken once the peri-implant soft tissue has been stabilized.

### Healing cap, bottleneck

In esthetically challenging areas, the treatment outcome can be optimized by using healing caps, bottleneck. The coronally tapered crosscut enables soft-tissue generation during healing.

After 3-4 weeks (and before the final organization of the elastic fibers) a healing cap cylindrical is screwed in. No tissue should be excised.

The tissue is coronally suppressed and thereby forms a papilla-like structure. The impression is taken once the peri-implant soft tissue has stabilized.

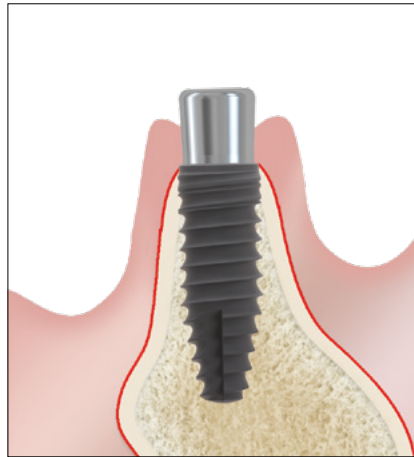

Healing cap, cylindrical

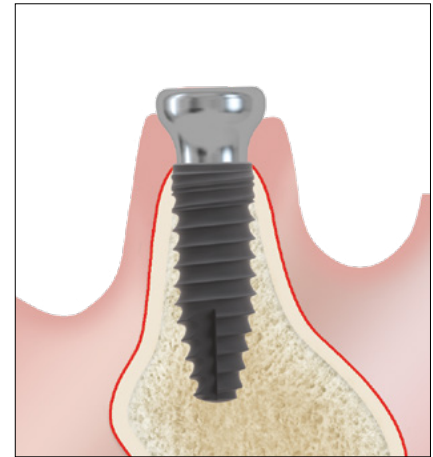

Healing cap, wide body

Single-stage surgery may be accomplished by placing a healing abutment at the time of implant surgery. This eliminates the need for a second procedure. Although the implant is not in occlusal function, some forces can be transmitted to it through the exposed transmucosal element.

Prosthetic restoration begins following osseointegration of the implant and soft tissue healing.

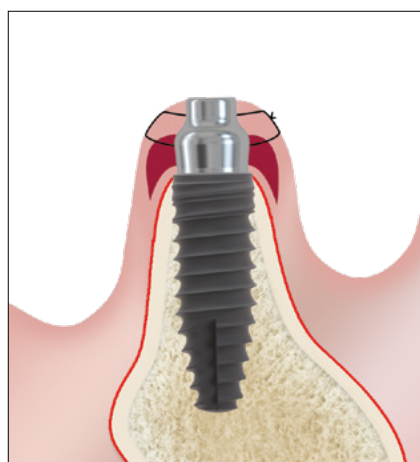

Healing phase

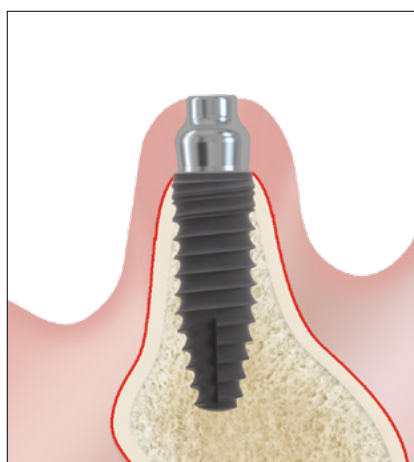

Soft-tissue generation



Coronal suppression of the soft tissue by substitution with a Healing cap, cylindrical

# Loading protocols

## Non-functional Immediate Restoration

Single-stage surgery with non-functional immediate provisionalization provides the patient with a non-occlusally loaded provisional prosthesis early in the treatment plan. An abutment is placed on the implant at, or shortly after surgery, and a provisional restoration is secured using temporary cement. The provisional can help contour the soft tissue profile during healing.



## Immediate Function Restoration

Single-stage surgery with immediate function can only be performed if the primary stability achieved is adequate for functional loading. Splinting implants together may offer a biomechanical advantage over individual, unsplinted prostheses.



## Further documentation

Further information on the CONELOG® Products can be found in the following documents:

- CONELOG® Product catalog
  - CONELOG® Working instructions
  - CONELOG® Instructions for use
  - Preparation instructions
  - Camlog literature overview
  - Camlog and science
1. Buser D, Von Arx T. Surgical procedures in partially edentulous patients with ITI implants. Clin. Oral Impl. Res. 2000; (11) Suppl 1, 83-100.
  2. Schwarz F, Alcoforado G, Nelson K, Schaer A, Taylor T, Beuer F, Strietzel FP. Impact of implant-abutment connection, positioning of the machined collar/microgap, and platform switching on crestal bone level changes. CAMLOG Foundation Consensus Report. Clin.Oral Impl. Res. 2014; 25(11): 1301-1303.
  3. Semper-Hogg, W, Kraft, S, Stiller, S et al. Analytical and experimental position stability of the abutment in different dental implant systems with a conical implant-abutment connection Clin Oral Invest (2013) 17: 1017
  4. Semper Hogg W, Zulauf K, Mehrhof J, Nelson K. The influence of torque tightening on the position stability of the abutment in conical implant-abutment connections. Int J Prosthodont 2015;28:538-41
  5. CONELOG® Implant System – Facts and Figures at a Glance (White Paper), Art. No. XJ7815.09/2020
  6. Bone quality as documented in Lekholm U, Zarb GA. Patient selection and preparation. In: Branemark PI, Zarb GA, Albrektsson T, editors. Tissue-integrated prostheses-Osseointegration in Clinical Dentistry. Chicago: Quintessence Publishing Co. 1985; p.199-209.

See also:

<https://ifu.camlog.com>  
[www.camlog.com](http://www.camlog.com)

Manufacturer CAMLOG® and CONELOG® Products:  
ALTATEC GmbH | Maybachstr. 5 | 71299 Wimsheim | Germany



### Trademarks and copyright

Protected trade names (trademarks) are not specially indicated. The absence of such an indication does NOT mean that it is not a protected trademarked name. The document including all its parts is protected by copyright. Its contents may be downloaded for personal non-commercial use, but no changes to or reproduction of the contents are permitted. Any exploitation beyond the narrow limits of the copyright act is not permitted without prior written approval of CAMLOG Biotechnologies GmbH and is subject to legal sanctions.

# Direct Offices

BioHorizons USA  
888-246-8338 or 205-967-7880

BioHorizons Canada  
866-468-8338

BioHorizons Spain  
+34 91 713 10 84

BioHorizons UK  
+44 (0)1344 752560

BioHorizons Chile  
+56 (2) 23619519

BioHorizons Italy  
800-063-040

BioHorizons Mexico  
800-953-0498

# Distributors

For contact information in our 90 countries, visit [biohorizons.com](http://biohorizons.com)



shop online at  
[store.biohorizons.com](http://store.biohorizons.com)

BioHorizons®, Laser-Lok®, MinerOss®, AutoTac®, Mem-Lok® and TeethXpress® are registered trademarks of BioHorizons. Unigrip™ is a trademark of Nobel Biocare AB. Zimmer® Dental ScrewVent® and Tapered ScrewVent® are registered trademarks of Zimmer, Inc. AlloDerm™, AlloDerm GBR™ and NovoMatrix™ are trademarks of LifeCell Corporation, an Allergan affiliate. Grafton® DBM is a registered trademark of Medtronic, Inc. Cytoplast® is a registered trademark of Osteogenics Biomedical, Inc. Puros Dermis is a registered trademark of Zimmer Biomet. Mucograft is a registered trademark of Ed. Geistlich Sogne Ag Fur Chemische Industrie. Symbios PerioDerm is a registered trademark of Dentsply Sirona. Hu-Friedy® is a registered trademark of Hu-Friedy Mfg. Co., LLC. Spiralock® is a registered trademark of Spiralock Corporation. Pomalux® is a registered trademark of Westlake Plastics Co. Locator® is a registered trademark of Zest Anchors, Inc. Delrin® is a registered trademark of E.I. du Pont de Nemours and Company. Bio-Gide® is a registered trademark of Edward Geistlich Sohne AG Fur Chemische Industrie. BioMend® is a registered trademark of Zimmer Biomet Dental. IntraSpin®, L-PRF® and Xpression® are trademarks of Intra-Lock® International Inc. Not all products shown or described in this literature are available in all countries. We are proud to be registered to ISO 13485:2016, the international quality management system standard for medical devices, which supports and maintains our product licences with Health Canada and in other markets around the globe. Original language is English. ©BioHorizons. All Rights Reserved.

Art. No. J8002.0357 Rev.01 03/2021

